

JULY-2024
PRICELIST - SW 02



Mfg. by : FVBROS MODDULAR PVT. LTD.
Bldg. No.8, Rajprabha Land Mark Industrial Estate,
Satali Road, Gokhivare, Vasai (E), Palghar - 401208.
Email: customercare@fybros.com
Website: www.fybros.com
Customer Care No.: 1800-270-6334
WhatsApp Virtual Assistant: 707-070-6737



SCAN THE QR CODE
TO VISIT FVBROS WEBSITE



Redefining Luxury

Dare To Dream With Me

Founded in 1968, FYBROS manufactures electrical products of unparalleled quality. Through these decades, we have refined our design process to design products of superior quality that have enabled our customers to create their dream homes. We have developed innovative products that are uniquely distinct, which have set the highest standards in product development in the industry, leading to unprecedented success. Present in a variety of sectors, we continuously develop products to meet market and customers ever evolving needs. With an astute understanding of your specific lifestyle desires, FYBROS products are easy to install, fit for its preferred purposes and designed for every decor. Ultimately, the products we make are elegant, dynamic, and infused with a passion to make your dreams come true.

FYBROS Moddular Pvt. Ltd.
(Brand Ambassador)

Shruti Haasan



TOGETHER

Series 3 Pure White Plate With Gate Switches in Pure White



Series 5 Snow White Plate With Glide Switches in Pure White



FOUR-X
MODULAR SERIES

FOUR-X

SWITCHES	01-03
ACCESSORIES	04-09
F-TOUCH SWITCH	10-12
PLATES	13-17
SURFACE GANG BOX / METAL GANG BOX	18
COLOUR	19-20

FAVIO

SWITCHES	23-25
ACCESSORIES	26-29
PLATES	30-34
COLOUR	35-36

WOOD~em

SWITCHES	39-45
ACCESSORIES	46-49
PLATES	51-56
SURFACE GANG BOX / METAL GANG BOX	57-59
COLOUR	60-62

ZINE

SWITCH & ACCESSORIES	65-67
----------------------	-------

ZINE PLUS

ACCESSORIES / TRAVEL ADAPTOR	69-70
BELL	71
NIGHT LAMP / FLEX BOX	72
SPIKE GUARD / POWER STRIP	73
HOLDER / CUBE WOOD PLATE	74-76

ZUNIX

SWITCH & ACCESSORIES	79-81
----------------------	-------

They are not
just functional,
but a
style
statement



Series 3 Emerald Chrome Plate With Grace Switches in Metallic Chrome

Grace Switch

Sharp contours, distinct cuts and smooth surface. Making the ordinary simply extraordinary. The switch deserves to grace your aesthetically designed walls.

Let style meet perfection! The new Series-3 modular plates comes with sharp-curved edges that fits perfectly on the walls and compliments your home interior even more. Available in different color options, series 3 includes the best-in-class switches that add meaning to beautification.

These are not
meant to be
hidden in a
corner, but
**draws
your eyes**



Series 5 Metallic Chrome Plate With Glide Switches in Metallic Chrome

Glide

Switch

Aesthetically designed with curved contours, the switch literally makes your finger glide upon touching its smooth surface. Just perfect to complement your designer walls.

The Series-5 is a range of modular plates that delivers serenity, relaxation and harmony with its great balance of shape, colours and functions. The uncluttered design convey the feeling of comfort and creates a visually presence space.

Touch and
feel it's
Premiumness.



Series 7 Alloy Chrome Plate With F-touch Fan Regulator in Metallic Chrome

F-touch Switch

The Magic Touch Style and functionality designed around you. The gentle touch of your fingertips lets you switch on to a world you can call your very own.

Compact and Stylish, the Series-7 Wood Suitable Plate are a perfect blend of flair and aesthetics. Comes with a curved shape and prove to be an accurate fit for wooden boxes. Install the Series-7 Wood Suitable Plate and make the visitors cherish the perfection.

Switch to
a new Dimension of
Beauty

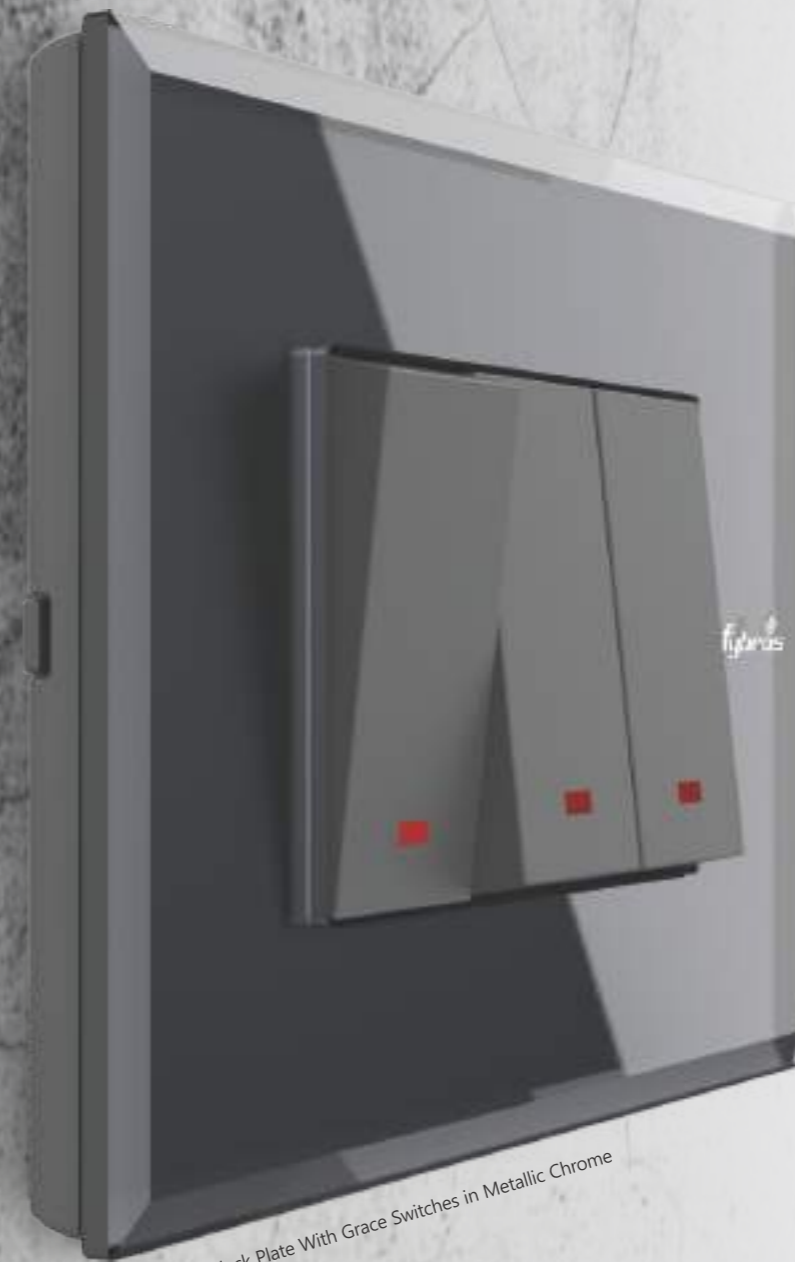

Series 9 Coal Black Plate With Grace Switches in Metallic Chrome

Grace

Switch

Sharp contours, distinct cuts and smooth surface. Making the ordinary simply extraordinary. The switch deserves to grace your aesthetically designed walls.

Art meets impression. With its sleek and minimalistic design. Add a touch of elegance and grandeur with our Series-9 sleek Glass plates, that will reflect your panache of life.

**Discover the Art
of Space
Transformation**



Series 11 Lava Chrome Plate With Glam Switches in Metallic Chrome

Glam Switch

With their sleek design, they add a touch of sophistication and elegance. The unique bar-shaped switches are ergonomic and also adds a visual treat to any modern interior.

Crafted to elevate the ambiance of your interiors! Meticulously designed from premium materials, our cover plates embody sophistication and refinement. Embrace the perfect combination of functionality and aesthetics with our elegant Series 11 cover plates.

FOUR-X
MODULAR SERIES

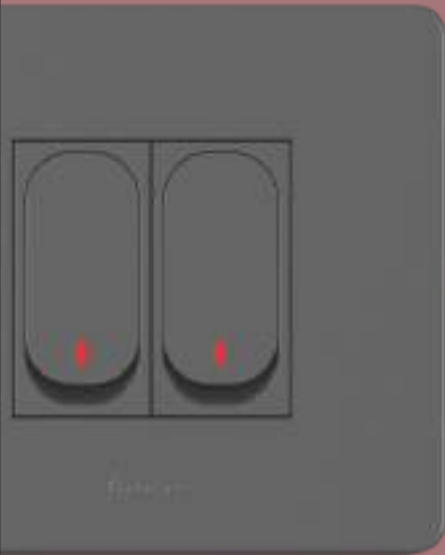

We continually create products that is based on our imagination of how life should be. This helps us to create super functional products that enables the pursuit of a perfect, trouble free life. The Four-X is a series of products which keeps reinventing itself to adapt to the modern demands of life. A range of avant garde switches, it provides a lifestyle that is on another dimension. By continuously creating products that is based on international standards, we ensure that the usage of our products is a perpetual celebration of life!

**Not Designs, but a
style
statement.**



CODE	ITEM	MRP(Rs.)	PURE WHITE	METALLIC CHROME/BLACK	PKG OUTER / MASTER
FOUR-X GRACE 10AX SWITCHES 240V~					
FX 1 101	1 Way Switch	62.00	70.00	20 / 1000	
FX 1 102	1 Way Switch with Indicator (LED)	128.00	142.00	20 / 1000	
FX 1 103	2 Way Switch	128.00	142.00	20 / 1000	
FX 1 104	Bell Push Switch	139.00	155.00	20 / 1000	
FX 1 105	Bell Push Switch with Indicator (LED)	156.00	175.00	20 / 1000	

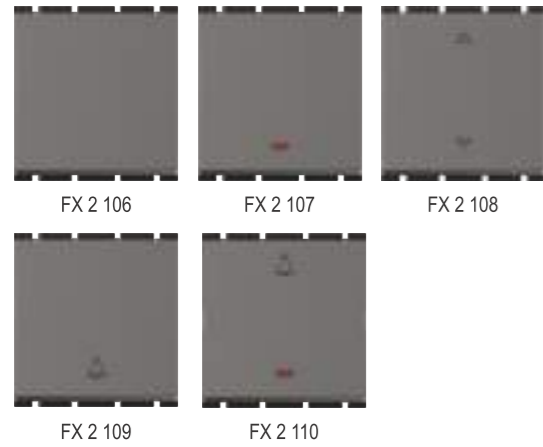

CODE	ITEM	MRP(Rs.)	PURE WHITE	METALLIC CHROME/BLACK	PKG OUTER / MASTER
FOUR-X GRACE 10AX SWITCHES 240V~					
FX 2 106	1 Way Switch	139.00	156.00	10 / 500	
FX 2 107	1 Way Switch with Indicator (LED)	169.00	191.00	10 / 500	
FX 2 108	2 Way Switch	169.00	191.00	10 / 500	
FX 2 109	Bell Push Switch	177.00	199.00	10 / 500	
FX 2 110	Bell Push Switch with Indicator (LED)	184.00	208.00	10 / 500	



CODE	ITEM	MRP(Rs.)	PURE WHITE	METALLIC CHROME/BLACK	PKG OUTER / MASTER
FOUR-X GRACE 20AMP / 25AMP SWITCHES 240V~					
FX 1 111	20A 1 Way Switch	155.00	164.00	20 / 1000	
FX 1 112	20A 1 Way Switch with Indicator (LED)	199.00	216.00	20 / 1000	
FX 1 113	20A 2 Way Switch	197.00	222.00	20 / 1000	
FX 1 114	25A 1 Way Switch	216.00	243.00	20 / 1000	

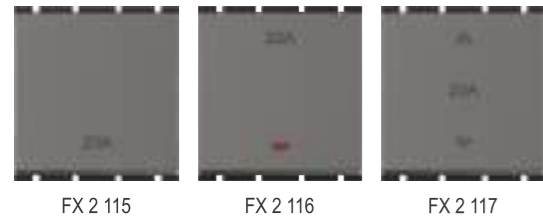

CODE	ITEM	MRP(Rs.)	PURE WHITE	METALLIC CHROME/BLACK	PKG OUTER / MASTER
FOUR-X GRACE 20AMP SWITCHES 240V~					
FX 2 115	20A 1 Way Switch	183.00	206.00	10 / 500	
FX 2 116	20A 1 Way Switch with Indicator (LED)	207.00	234.00	10 / 500	
FX 2 117	20A 2 Way Switch	218.00	246.00	10 / 500	



CODE	ITEM	MRP(Rs.)	PURE WHITE	METALLIC CHROME/BLACK	PKG OUTER / MASTER
FOUR-X GRACE 32AMP DP SWITCH 240V~					
FX 2 120	32A DP Switch with Indicator (LED)	344.00	386.00	10 / 500	

CODE	ITEM	MRP(Rs.)	PURE WHITE	METALLIC CHROME/BLACK	PKG OUTER / MASTER
FOUR-X GLIDE 10AX SWITCHES 240V~					
FX 1 401	1 Way Switch	67.00	77.00	20 / 1000	
FX 1 402	1 Way Switch with Indicator (LED)	136.00	151.00	20 / 1000	
FX 1 403	2 Way Switch	136.00	151.00	20 / 1000	
FX 1 404	Bell Push Switch	154.00	169.00	20 / 1000	
FX 1 405	Bell Push Switch with Indicator (LED)	172.00	190.00	20 / 1000	



CODE	ITEM	MRP(Rs.)	PURE WHITE	METALLIC CHROME/BLACK	PKG OUTER / MASTER
FOUR-X GLIDE 10AX SWITCHES 240V~					
FX 2 406	1 Way Switch	154.00	172.00	10 / 500	
FX 2 407	1 Way Switch with Indicator (LED)	191.00	212.00	10 / 500	
FX 2 408	2 Way Switch	191.00	212.00	10 / 500	
FX 2 409	Bell Push Switch	199.00	221.00	10 / 500	
FX 2 410	Bell Push Switch with Indicator (LED)	209.00	233.00	10 / 500	



CODE	ITEM	MRP(Rs.)	PURE WHITE	METALLIC CHROME/BLACK	PKG OUTER / MASTER
FOUR-X GLIDE 20AMP / 25AMP SWITCHES 240V~					
FX 1 411	20A 1 Way Switch	168.00	178.00	20 / 1000	
FX 1 412	20A 1 Way Switch with Indicator (LED)	211.00	226.00	20 / 1000	
FX 1 413	20A 2 Way Switch	209.00	234.00	20 / 1000	
FX 1 414	25A 1 Way Switch	228.00	255.00	20 / 1000	



CODE	ITEM	MRP(Rs.)	PURE WHITE	METALLIC CHROME/BLACK	PKG OUTER / MASTER
FOUR-X GLIDE 20AMP SWITCHES 240V~					
FX 2 415	20A 1 Way Switch	207.00	230.00	10 / 500	
FX 2 416	20A 1 Way Switch with Indicator (LED)	235.00	263.00	10 / 500	
FX 2 417	20A 2 Way Switch	250.00	278.00	10 / 500	



CODE	ITEM	MRP(Rs.)	PURE WHITE	METALLIC CHROME/BLACK	PKG OUTER / MASTER
FOUR-X GLIDE 32AMP DP SWITCH 240V~					
FX 2 420	32A DP Switch with Indicator (LED)	382.00	425.00	10 / 500	





CODE	ITEM	MRP(Rs.)	PURE WHITE	METALLIC CHROME/BLACK	PKG OUTER / MASTER
------	------	----------	------------	-----------------------	--------------------

FOUR-X GLAM 10AX SWITCHES 240V~ NEW

FX 1 501	1 Way Switch	62.00	70.00	20 / 1000
FX 1 502	1 Way Switch with Indicator (LED)	128.00	142.00	20 / 1000
FX 1 503	2 Way Switch	128.00	142.00	20 / 1000
FX 1 504	Bell Push Switch	139.00	155.00	20 / 1000
FX 1 505	Bell Push Switch with Indicator (LED)	156.00	175.00	20 / 1000

FOUR-X GLAM 10AX SWITCHES 240V~ NEW

FX 2 506	1 Way Switch	139.00	156.00	10 / 500
FX 2 507	1 Way Switch with Indicator (LED)	169.00	191.00	10 / 500
FX 2 508	2 Way Switch	169.00	191.00	10 / 500
FX 2 509	Bell Push Switch	177.00	199.00	10 / 500
FX 2 510	Bell Push Switch with Indicator (LED)	184.00	208.00	10 / 500

FOUR-X GLAM 20AMP / 25AMP SWITCHES 240V~ NEW

FX 1 511	20A 1 Way Switch	155.00	164.00	20 / 1000
FX 1 512	20A 1 Way Switch with Indicator (LED)	199.00	216.00	20 / 1000
FX 1 513	20A 2 Way Switch	197.00	222.00	20 / 1000
FX 1 514	25A 1 Way Switch	216.00	243.00	20 / 1000

FOUR-X GLAM 20AMP SWITCHES 240V~ NEW

FX 2 515	20A 1 Way Switch	183.00	206.00	10 / 500
FX 2 516	20A 1 Way Switch with Indicator (LED)	207.00	234.00	10 / 500
FX 2 517	20A 2 Way Switch	218.00	246.00	10 / 500

FOUR-X GLAM 32AMP DP SWITCH 240V~ NEW

FX 2 520	32A DP Switch with Indicator (LED)	344.00	386.00	10 / 500
----------	------------------------------------	--------	--------	----------

CODE	ITEM	MRP(Rs.)	PURE WHITE	METALLIC CHROME/BLACK	PKG OUTER / MASTER
------	------	----------	------------	-----------------------	--------------------

FOUR-X 6AMP / 13AMP SOCKETS 240V~

FX 1 121	6A 2 Pin Socket with safety shutter	112.00	128.00	20 / 1000
FX 2 122	6A 2x1 Socket with safety shutter	136.00	154.00	10 / 500
FX 2 123	6A 2x1 Socket without safety shutter	125.00	144.00	10 / 500
FX 2 124	6A 3 Pin Socket with safety shutter	132.00	152.00	10 / 500
FX 2 125	6A 3 Pin Socket without safety shutter	125.00	144.00	10 / 500
FX 2 126	13A International Socket with safety shutter	222.00	251.00	10 / 500

FOUR-X 6&16AMP / 6&25AMP SOCKETS 240V~

FX 2 131	6&16A Universal Socket with safety shutter	262.00	280.00	10 / 500
FX 2 132	6&25A Universal Socket with safety shutter	272.00	307.00	10 / 500
FX 2 133	6&16A Universal Raised Socket with safety shutter	249.00	280.00	10 / 500
FX 2 134	6&25A Universal Raised Socket with safety shutter	272.00	307.00	10 / 500

FOUR-X DIMMER / FAN REGULATOR 240V~

FX 1 141	ORO Mini Dimmer	312.00	352.00	20 / 600
FX 1 146	ORO 4 Step Regulator	456.00	493.00	20 / 600
FX 1 149	ORION 4 Step Regulator	456.00	493.00	20 / 600

FOUR-X DIMMER / FAN REGULATOR 240V~

FX 2 142	ORO Medium Dimmer	378.00	425.00	10 / 300
FX 2 147	ORO 5 Step Regulator Full Rotary	511.00	553.00	10 / 300
FX 2 148	OCEAN 5 Step Regulator Half Rotary	511.00	553.00	10 / 300
FX 2 150	ORION 5 Step Regulator Full Rotary	511.00	553.00	10 / 300

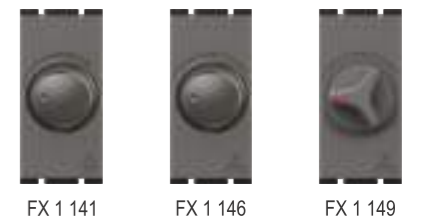
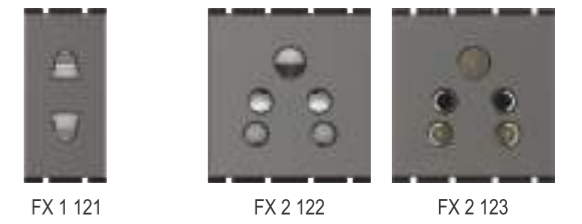



CODE	ITEM	MRP(Rs.)	PURE WHITE	METALLIC CHROME/BLACK	PKG OUTER/MASTER
FOUR-X MOTOR STARTER (SP) 240V~ 50-60Hz					
FX 2 151	16A Motor Starter Switch		629.00	717.00	10 / 300
FX 2 152	20A Motor Starter Switch		629.00	717.00	10 / 300
FX 2 153	25A Motor Starter Switch		629.00	717.00	10 / 300



CODE	ITEM	MRP(Rs.)	PURE WHITE	METALLIC CHROME/BLACK	PKG OUTER/MASTER
FOUR-X TV SOCKET / RJ-11 TEL. JACKS / EDP SOCKET					
FX 1 155	TV Socket Coaxial 40-862 Mhz socket		135.00	154.00	20 / 1000
FX 1 156	Telephone Jack - RJ 11		139.00	158.00	20 / 1000
FX 1 157	EDP Socket Outlet - RJ 45 (5e) Universal wiring T568a, Insulating- piercing terminal		298.00	347.00	20 / 1000
FX 1 158	EDP Socket Outlet - RJ 45 (6e) Universal wiring T568a, Insulating- piercing terminal		666.00	714.00	20 / 1000



CODE	ITEM	MRP(Rs.)	PURE WHITE	METALLIC CHROME/BLACK	PKG OUTER/MASTER
FOUR-X TESLA SINGLE POLE MCBs 240V~ 50Hz					
FX 1 161	6A SP MCB		347.00	394.00	20 / 600
FX 1 162	10A SP MCB		347.00	394.00	20 / 600
FX 1 163	16A SP MCB		347.00	394.00	20 / 600
FX 1 164	20A SP MCB		347.00	394.00	20 / 600
FX 1 165	25A SP MCB		347.00	394.00	20 / 600
FX 1 166	32A SP MCB (Breaking Capacity - 3kA)		347.00	394.00	20 / 600

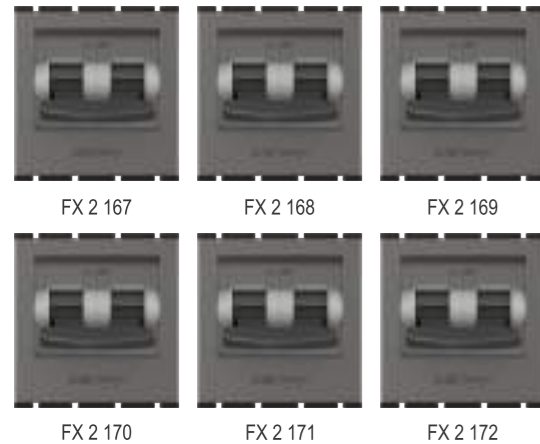

CODE	ITEM	MRP(Rs.)	PURE WHITE	METALLIC CHROME/BLACK	PKG OUTER/MASTER
FOUR-X TESLA DOUBLE POLE MCBs 240V~ 50Hz					
FX 2 167	6A DP MCB		700.00	803.00	10 / 300
FX 2 168	10A DP MCB		700.00	803.00	10 / 300
FX 2 169	16A DP MCB		700.00	803.00	10 / 300
FX 2 170	20A DP MCB		700.00	803.00	10 / 300
FX 2 171	25A DP MCB		700.00	803.00	10 / 300
FX 2 172	32A DP MCB (Breaking Capacity - 3kA)		700.00	803.00	10 / 300

CODE	ITEM	MRP(Rs.)	PURE WHITE	METALLIC CHROME/BLACK	PKG OUTER/MASTER
FOUR-X OVIUS SINGLE POLE MCBs 240V~ 50Hz					
FX 1 261	6A SP MCB		347.00	394.00	20 / 600
FX 1 262	10A SP MCB		347.00	394.00	20 / 600
FX 1 263	16A SP MCB		347.00	394.00	20 / 600
FX 1 264	20A SP MCB		347.00	394.00	20 / 600
FX 1 265	25A SP MCB		347.00	394.00	20 / 600
FX 1 266	32A SP MCB (Breaking Capacity - 3kA)		347.00	394.00	20 / 600



CODE	ITEM	MRP(Rs.)	PURE WHITE	METALLIC CHROME/BLACK	PKG OUTER/MASTER
FOUR-X OVIUS DOUBLE POLE MCBs 240V~ 50Hz					
FX 2 267	6A DP MCB		700.00	803.00	10 / 300
FX 2 268	10A DP MCB		700.00	803.00	10 / 300
FX 2 269	16A DP MCB		700.00	803.00	10 / 300
FX 2 270	20A DP MCB		700.00	803.00	10 / 300
FX 2 271	25A DP MCB		700.00	803.00	10 / 300
FX 2 272	32A DP MCB (Breaking Capacity - 3kA)		700.00	803.00	10 / 300

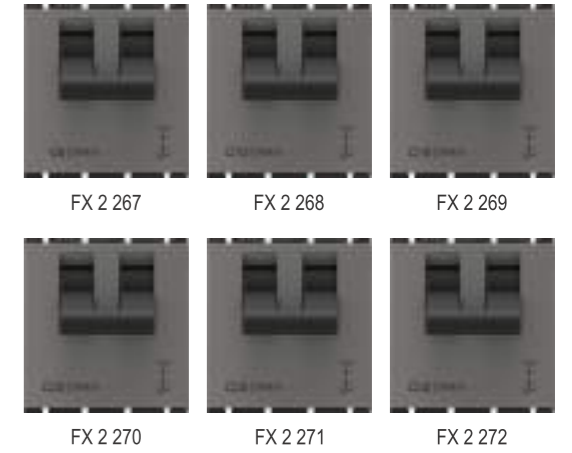

CODE	ITEM	MRP(Rs.)	PURE WHITE	METALLIC CHROME/BLACK	PKG OUTER/MASTER
FOUR-X INDICATOR / BLANK MODULE / FUSE UNIT					
FX 1 176	XION Indicator with Led & Red diffuser		105.00	120.00	20 / 1000
FX 1 177	ORREN Indicator with Led & Red diffuser		105.00	120.00	20 / 1000
FX 1 179	Blank Module		23.00	29.00	50 / 2000
FX 1 180	Kitkat Fuse (10A / 16Amp) with miniature fuse		161.00	184.00	20 / 1000



CODE	ITEM	MRP(Rs.)	PURE WHITE	METALLIC CHROME/BLACK	PKG OUTER/MASTER
FOUR-X POP-OUT NIGHT LAMP 240V~ 50-60Hz					
FX 2 183 WH	Night Lamp (LED - White) advance LED light on / off system		641.00	717.00	10 / 240
FX 2 183 WW	Night Lamp (LED - Warm White) advance LED light on / off system		641.00	717.00	10 / 240
FX 2 183 BL	Night Lamp (LED - Blue) advance LED light on / off system		641.00	717.00	10 / 240

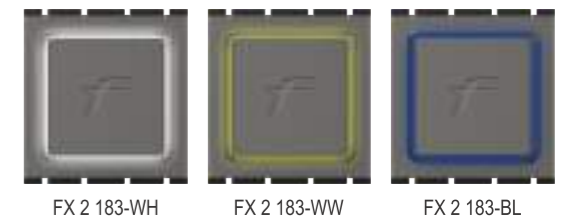

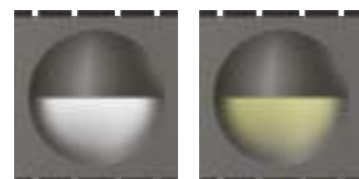

FX 2 184-WH FX 2 184-WW

CODE	ITEM	MRP(Rs.)	PURE WHITE	METALLIC CHROME/BLACK	PKG OUTER / MASTER
FOUR-X STEP MARKER 240V~ 50-60Hz					
FX 2 184 WH	Step Marker (LED - White) with high-efficiency		455.00	532.00	10 / 240
FX 2 184 WW	Step Marker (LED - Warm White) with high-efficiency		455.00	532.00	10 / 240



FX 3 185-WH FX 3 185-WW

CODE	ITEM	MRP(Rs.)	PURE WHITE	METALLIC CHROME/BLACK	PKG OUTER / MASTER
FOUR-X STEP MARKER 240V~ 50-60Hz					
FX 3 185 WH	BRIO Step Marker (LED - White) with high-efficiency		706.00	811.00	10 / 200
FX 3 185 WW	BRIO Step Marker (LED - Warm White) with high-efficiency		706.00	811.00	10 / 200
FX 3 186 WH*	LUMI Step Marker (LED - White) (New) with high-efficiency & Sensor		706.00	811.00	10 / 200
FX 3 186 WW*	LUMI Step Marker (LED - Warm White) (New) with high-efficiency & Sensor		706.00	811.00	10 / 200



FX 3 186-WH FX 3 186-WW



FX 2 197 FX 1 209

CODE	ITEM	MRP(Rs.)	PURE WHITE	METALLIC CHROME/BLACK	PKG OUTER / MASTER
FOUR-X ELECTRONIC BUZZER / CALL BELL IND. DISPLAY UNIT 240V~					
FX 2 197	Electronic Buzzer 240V~ 50-60Hz		425.00	458.00	10 / 240
FX 1 209	Call Bell with Indicator Reset Switch & Name Plate		376.00	422.00	20 / 600



FX 2 201 FX 2 202

CODE	ITEM	MRP(Rs.)	PURE WHITE	METALLIC CHROME/BLACK	PKG OUTER / MASTER
FOUR-X 32AMP MAIN SWITCH					
FX 2 201	32AMP. DP Main Switch with key tag 240V~, LED Supplied with key tag		525.00	597.00	10 / 500
FX 2 202	Key Tag Only with Name Plate		122.00	139.00	100 / 2000

* NEWLY INTRODUCED

CODE	ITEM	MRP(Rs.)	PURE WHITE	METALLIC CHROME/BLACK	PKG OUTER / MASTER
FOUR-X DND / MAKE MY ROOM 240V~					
FX 2 206	Do Not Disturb / Make My Room 240V~50-60Hz - Inside Room		503.00	572.00	10 / 300
FX 2 207	Do Not Disturb / Make My Room 240V~50-60Hz - Outside Room		534.00	611.00	10 / 300



FX 2 206 FX 2 207

CODE	ITEM	MRP(Rs.)	PURE WHITE	METALLIC CHROME/BLACK	PKG OUTER / MASTER
FOUR-X USB CHARGER 240V~					
FX 1 215	USB Charger with Usb port & Indicator Input 240V~ 50-60Hz Output-5V DC, 2A		819.00	901.00	20 / 600
FX 2 216	USB Charger with Usb port & Indicator Input 240V~ 50-60Hz Output-5V DC, 4A		1175.00	1275.00	10 / 300
FX 1 217*	USB Charger with Indicator (New) 1 Port C-Type (Fast Charging) Input 240V~ 50-60Hz Output-20W 3.1A		1150.00	1245.00	20 / 600
FX 1 218*	USB Charger with Indicator (New) 2 Port C-Type & A-Type (Fast Charging) Input 240V~ 50-60Hz Output-18W 3.1A		1371.00	1466.00	20 / 600



FX 1 215 FX 2 216



FX 1 217 FX 1 218

CODE	ITEM	MRP(Rs.)	PURE WHITE	METALLIC CHROME/BLACK	PKG OUTER / MASTER
FOUR-X HDMI / AUDIO VIDEO SOCKET 240V~					
FX 1 221	HDMI Socket		1408.00	1520.00	05 / 150
FX 1 222	Triple RCA Socket (Audio & Video)		972.00	1039.00	05 / 150



FX 1 221 FX 1 222

CODE	ITEM	MRP(Rs.)	PURE WHITE	METALLIC CHROME/BLACK	PKG OUTER / MASTER
FOUR-X FOOT LIGHT 240V~ 50-60Hz					
FX 4 226 WH	Foot Light (LED - White) with high-efficiency 2.0W Led		893.00	966.00	05 / 120
FX 4 226 WW	Foot Light (LED - Warm White) with high-efficiency 2.0W Led		893.00	966.00	05 / 120



FX 4 226-WH



FX 4 226-WW

* NEWLY INTRODUCED



FX 2 231

FX 2 233

CODE	ITEM	MRP(Rs.)	PURE WHITE	METALLIC CHROME/BLACK	PKG OUTER / MASTER
FOUR-X MOTION SENSOR / WAVE SWITCH 240V~					
FX 2 231	Motion Sensor Electronic Sensor Switch Supply voltage 180-240V~5A relay output Allows to control lights by simply passing in front of it (Max distance 8mtr.) Upto 5 Switches can be combined to control the same lighting circuit	3294.00		3794.00	05 / 60
FX 2 233	Wave Switch Electronic Sensor Switch Supply voltage 180-240V~5A relay output Allows to control lights by simply passing the hand in front of it (Max distance 30mm).Upto 5 Switches can be combined to control the same lighting circuit.	3294.00		3794.00	05 / 60

CODE	ITEM	MRP(Rs.)	METALLIC CHROME	PKG OUTER / MASTER
FOUR-X F-TOUCH SWITCHES / BELL PUSH 110 - 240V~				
FX 2 601	2 Switch - 6A each 6A Relay output, CFL - 200W Max. (each switch)	3734.00		05 / 60
FX 2 602	4 Switch - 6A each 6A Relay output, CFL - 200W Max. (each switch)	4283.00		05 / 60
FX 2 603	2 Way Switch - 6A 6A Relay output, CFL - 200W Max.	3404.00		05 / 60
FX 2 604	Bell Push Switch 6A Relay output	3734.00		05 / 60
FOUR-X F-TOUCH 25A SWITCH 110 - 240V~				
FX 2 605	25A Switch 25A Relay output	3734.00		05 / 60
FOUR-X F-TOUCH LIGHT DIMMER 110 - 240V~				
FX 2 606	Light Dimmer Triac Technology with soft end & soft start function operating load -300-450W (Not suitable for FAN)	3734.00		05 / 60
FOUR-X F-TOUCH FAN REGULATOR 110 - 240V~				
FX 2 607	4 Step Fan Regulator 6A Relay output with 4 steps fan coil speed operating Load (FAN) - 100W	4283.00		05 / 60
FOUR-X F-TOUCH DRAPE / CURTAIN CONTROLLER 110 - 240V~				
FX 2 608	Drape / Curtain controller 6A Relay output	4283.00		05 / 60

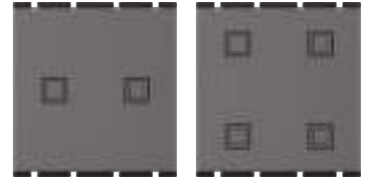

FX 2 601

FX 2 602



FX 2 603

FX 2 604



FX 2 605



FX 2 606



FX 2 607



FX 2 608

FOUR-X F-TOUCH SWITCH WIRING DIAGRAM

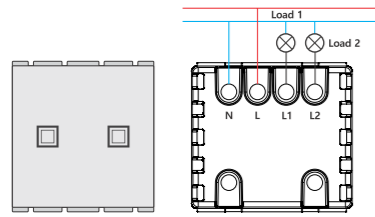

2 Switch

- Rated Voltage - 110-240V~
- Rated Load - Each Switch
- Resistive 6A.
- Incandescent Lamp - 1000W.
- Halogen with Transformer - 700W.
- Halogen without Transformer - 1000W.
- Compact Fluorescent Lamp - 200W.
- Inductive Motor Load (power factor 0.6 lag) 4A.

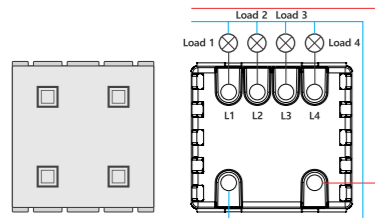

4 Switch

- Rated Voltage - 110-240V~
- Rated Load - Each Switch
- Resistive 6A.
- Incandescent Lamp - 1000W.
- Halogen with Transformer - 700W.
- Halogen without Transformer - 1000W.
- Compact Fluorescent Lamp - 200W.
- Inductive Motor Load (power factor 0.6 lag) 4A.

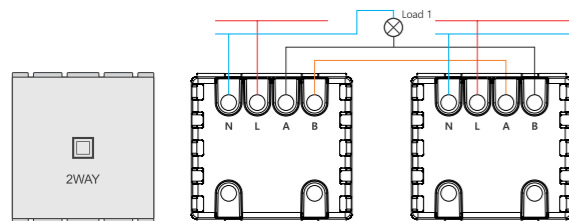

2 Way Switch

- Rated Voltage - 110-240V~
- Resistive 6A.
- Incandescent Lamp - 1000W.
- Halogen with Transformer - 700W.
- Halogen without Transformer - 1000W.
- Compact Fluorescent Lamp - 200W.
- Inductive Motor Load (power factor 0.6 lag) 4A.

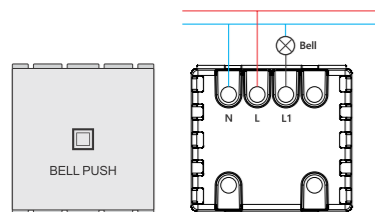

Bell Switch

- 1 Switch 2secs ON For Bell
- 6A Each Switch
- Rated Voltage - 110-240V~
- Resistive 6A.
- Inductive Bell Load (power factor 0.6 lag) 4A.
- Musical Bell
- 230V LEDS Lamps

Wire Colour Codes: ■ Red (Live) ■ Blue (Neutral) ■ Black (Load)

FOUR-X F-TOUCH SWITCH WIRING DIAGRAM

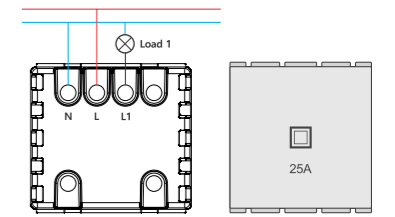

25A Switch

- Rated Voltage - 110-240V~
- Rated Load - Each Switch
- Resistive 25A.
- Incandescent Lamp - 3000W.
- Halogen with Transformer - 2000W.
- Halogen without Transformer - 3000W.
- Compact Fluorescent Lamp - 600W.
- Inductive Motor Load (power factor 0.6 lag) 6A.

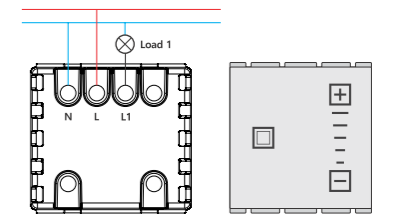

Light Dimmer

- Rated Voltage - 110-240V~
- Rated Load - 450W
- Incandescent Lamps
- Tested for 20,000 Switching Cycles at Rated Voltage and Rated Load

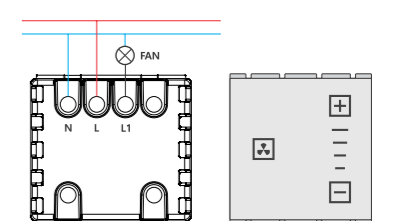

4 Step Fan Regulator

- Rated Voltage - 110-240V~
- Rated Load - 100W.
- No Loss Capacitor Speed Control
- Tested for 20,000 Switching Cycles at Rated Voltage and Rated Load

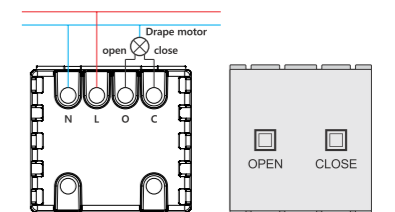

Drap / Curtain Controller

- Rated Voltage - 110-240V~
- Rated Load - 100W.
- Tested for 20,000 Switching Cycles at Rated Voltage and Rated Load

Wire Colour Codes: ■ Red (Live) ■ Blue (Neutral) ■ Black (Load)

SERIES 3 MODULAR PLATES WITH MOUNTING FRAMES - SUITABLE FOR METAL BOX															
Module⇨	1M	2M	3M*	3M	4M*	4M	6M*	6M	8M	8M	8M	12M	12M	16M	18M
							(H&V)**	(H&V)**	(H&V)**	(V)		(H&V)**			
Colours⇩	MRP	MRP	MRP	MRP	MRP	MRP	MRP	MRP	MRP	MRP	MRP	MRP	MRP	MRP	MRP
Natural	106.00	106.00	136.00	136.00	177.00	177.00	238.00	238.00	331.00	331.00	331.00	375.00	375.00	390.00	463.00
Metallic	148.00	148.00	186.00	186.00	248.00	248.00	326.00	326.00	417.00	417.00	417.00	521.00	521.00	529.00	641.00
Wood	173.00	173.00	222.00	222.00	298.00	298.00	390.00	390.00	495.00	495.00	495.00	635.00	635.00	664.00	774.00
PKG ⇨	10/500	10/500	10/400	10/400	10/400	10/400	10/200	10/200	10/200	10/200	10/200	05/120	05/120	05/90	05/80
CODE ⇨	S3 01 11	S3 02 12	S3 03 13	S3 03 25	S3 04 14	S3 04 15	S3 06 16	S3 06 17	S3 08 18	S3 08 19	S3 08 20	S3 12 21	S3 12 22	S3 16 23	S3 18 24
SIZE (mm)	99.5x93	99.5x93	124.5x93	124.5x93	151.5x93	151.5x93	223.5x93	223.5x93	250.5x93	270x93	157.5x163	225.5x163	225.5x163	270x163	225.5x224



* without Partition Plates ** suitable for horizontal & vertical installation

SERIES 3 MOUNTING FRAMES - HORIZONTAL & VERTICAL FOR FIXING (Dimensions in mm)

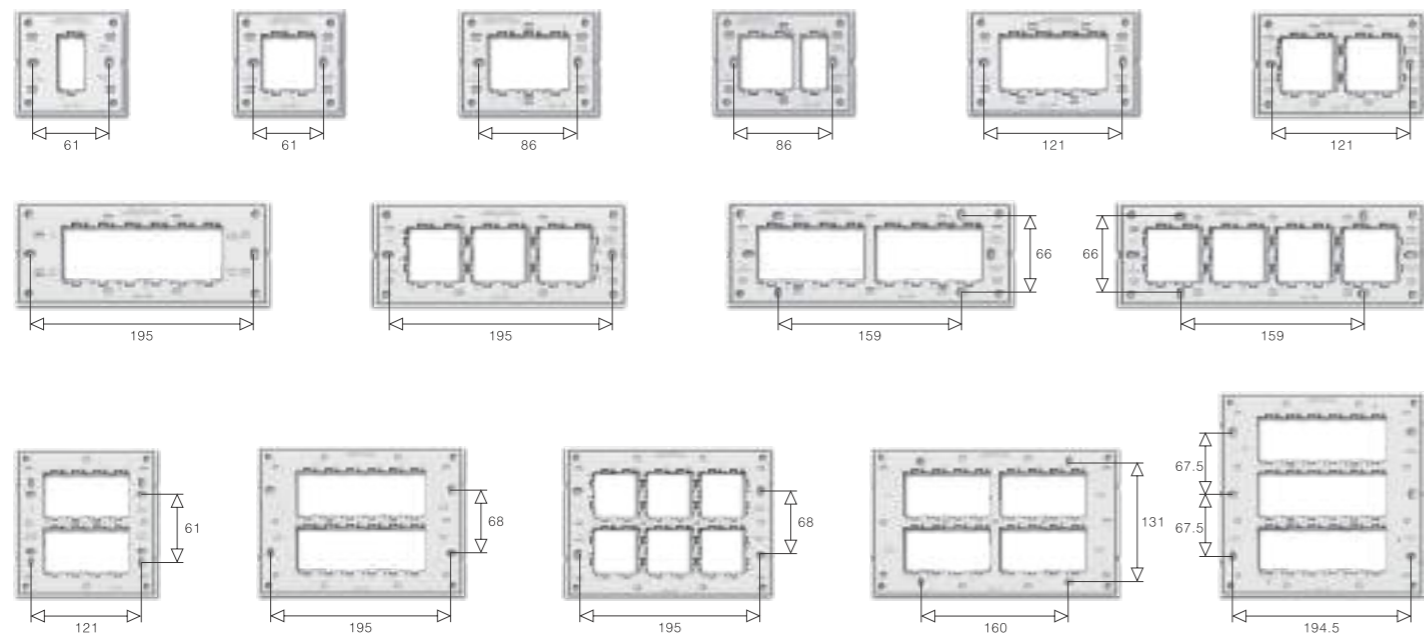

SERIES 5 MODULAR PLATES WITH MOUNTING FRAMES - SUITABLE FOR METAL BOX															
Module⇨	1M	2M	3M*	3M	4M*	4M	6M*	6M	8M*	8M	8M	12M	12M	16M	18M
							(H&V)**	(H&V)**	(H&V)**	(V)		(H&V)**			
Colours⇩	MRP	MRP	MRP	MRP	MRP	MRP	MRP	MRP	MRP	MRP	MRP	MRP	MRP	MRP	MRP
Natural	101.00	101.00	129.00	129.00	168.00	168.00	226.00	226.00	331.00	313.00	313.00	358.00	358.00	370.00	441.00
Metallic	141.00	141.00	178.00	178.00	237.00	237.00	310.00	310.00	417.00	396.00	396.00	495.00	495.00	503.00	607.00
Wood	164.00	164.00	211.00	211.00	285.00	285.00	371.00	371.00	495.00	470.00	470.00	606.00	606.00	632.00	737.00
PKG ⇨	10/500	10/500	10/400	10/400	10/400	10/400	10/200	10/200	10/200	10/200	10/200	05/120	05/120	05/90	05/80
CODE ⇨	S5 01 51	S5 02 52	S5 03 53	S5 03 65	S5 04 54	S5 04 55	S5 06 56	S5 06 57	S5 08 58	S5 08 59	S5 08 60	S5 12 61	S5 12 62	S5 16 63	S5 18 64
SIZE (mm)	98x91	98x91	121x91	121x91	152x91	152x91	220x91	220x91	265x91	285x91	152x168	220x157	220x157	270x161	220x222



* without Partition Plates ** suitable for horizontal & vertical installation

SERIES 5 MOUNTING FRAMES - HORIZONTAL & VERTICAL FOR FIXING (Dimensions in mm)

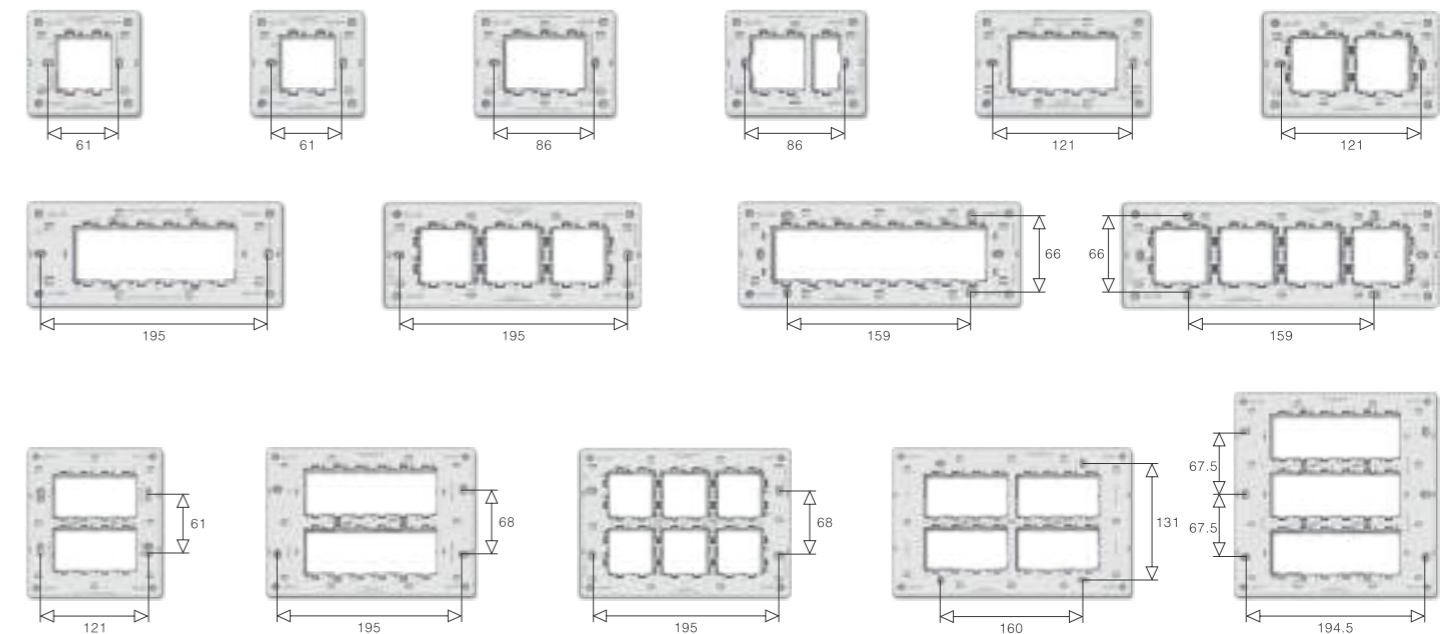

SERIES 7 WOODEN MODULAR PLATES WITH MOUNTING FRAMES - SUITABLE FOR WOODEN & METAL BOX

Module ⇨	1M	2M	3M*	4M	6M	8M	8M	10M	12M	12M	16M	18M	20M	24M
						(H)	(V) (New)		(H)	(V)		(H&V)**		
Colours ↓	MRP	MRP	MRP	MRP	MRP	MRP	MRP	MRP	MRP	MRP	MRP	MRP	MRP	MRP
Natural	118.00	118.00	148.00	202.00	268.00	318.00	318.00	371.00	418.00	469.00	444.00	535.00	670.00	831.00
Metallic	192.00	192.00	242.00	313.00	434.00	518.00	518.00	603.00	682.00	763.00	726.00	868.00	1093.00	1355.00
Wood	228.00	228.00	287.00	390.00	541.00	649.00	649.00	755.00	854.00	952.00	908.00	1085.00	1363.00	1693.00
PKG ⇨	10/400	10/400	10/400	10/300	10/200	10/200	10/160	10/150	10/120	10/120	10/90	10/80	10/80	10/80
CODE ⇨	S7 01 71	S7 02 72	S7 03 73	S7 04 74	S7 06 75	S7 08 76	S7 08 84	S7 10 77	S7 12 78	S7 12 79	S7 16 80	S7 18 81	S7 20 82	S7 24 83
SIZE (mm)	115x115	115x115	124x115	165x115	221x115	267x115	165x165	317x115	393x115	217x165	267x189	269x215	318x179	318x240

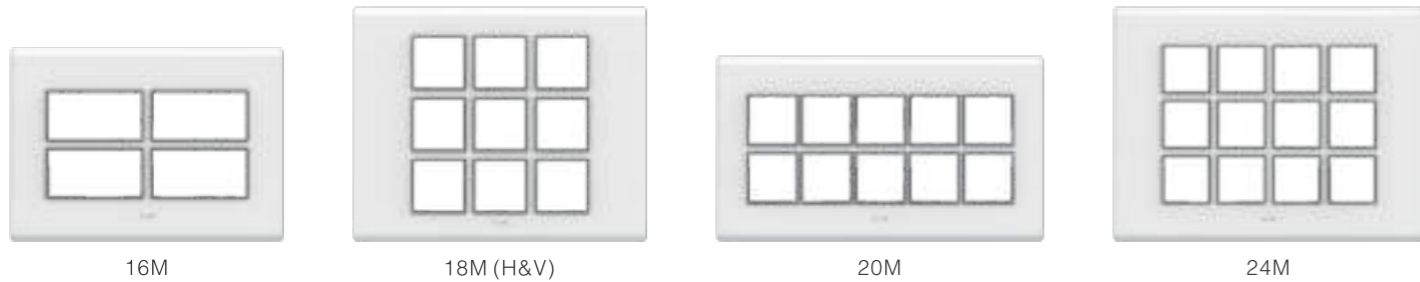
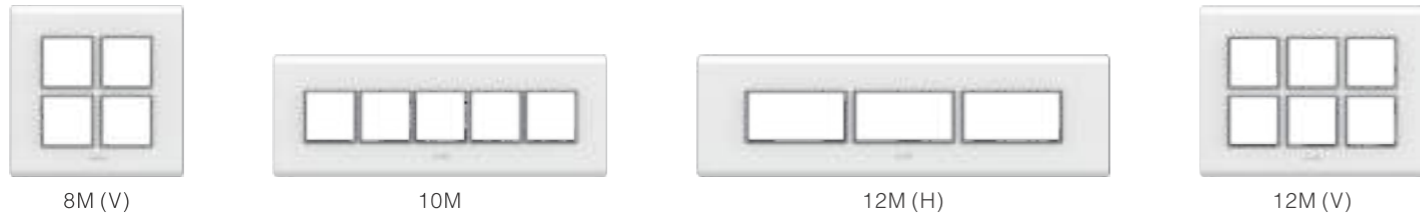

* without Partition Plates ** suitable for horizontal & vertical installation

SERIES 7 MOUNTING FRAMES - HORIZONTAL & VERTICAL FOR FIXING (Dimensions in mm)

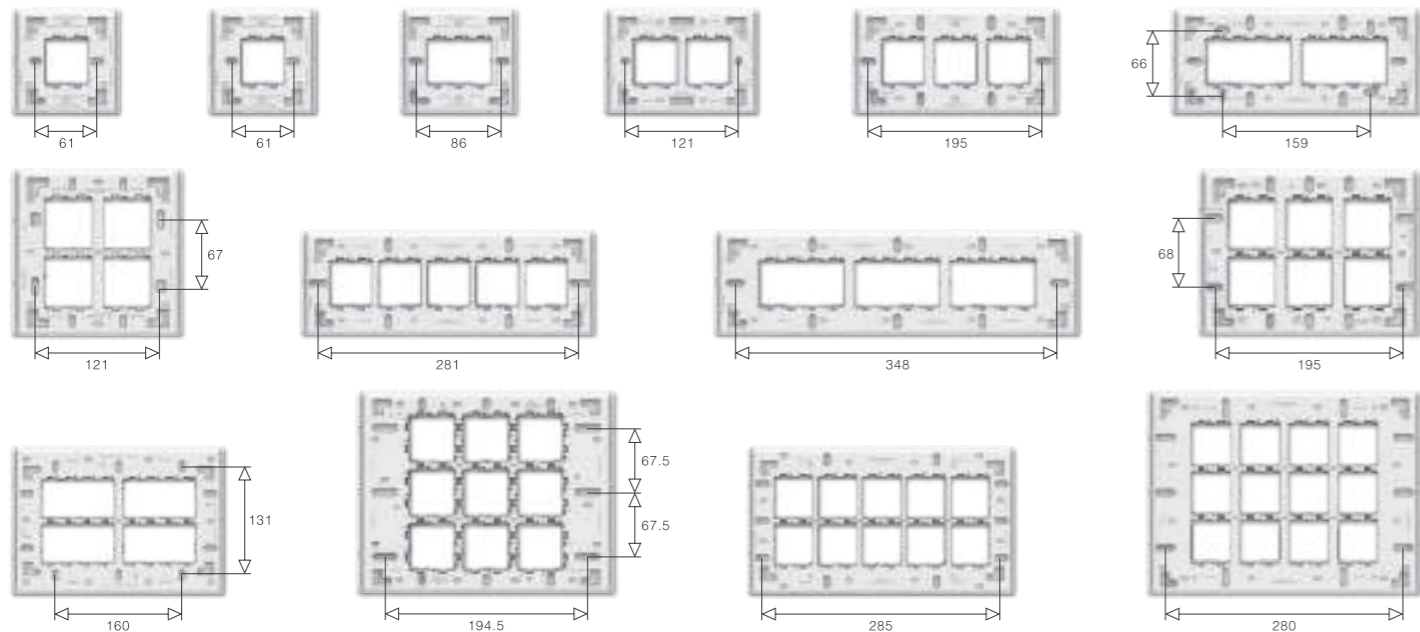

* NEWLY INTRODUCED

SERIES 9 GLASS COVER PLATES - SUITABLE FOR METAL BOX (without Frame)

Module ⇨	1M	2M	3M	4M	6M	8M (H)	8M (V)	12M	16M	18M
Colours ↓	MRP ₹	MRP ₹	MRP ₹	MRP ₹	MRP ₹	MRP ₹	MRP ₹	MRP ₹	MRP ₹	MRP ₹
Glass without Frame	617.00	617.00	870.00	1146.00	1652.00	1856.00	1856.00	2085.00	2397.00	2555.00
PKG ⇨	10/160	10/160	10/160	10/160	05/90	05/90	05/90	05/60	05/40	05/40
CODE ⇨	S9 01 91	S9 02 92	S9 03 93	S9 04 94	S9 06 95	S9 08 96	S9 08 97	S9 12 98	S9 16 100	S9 18 99
SIZE (mm)	106x91	106x91	128x91	152x91	226x91	252x91	152x157	226x157	252x157	226x224

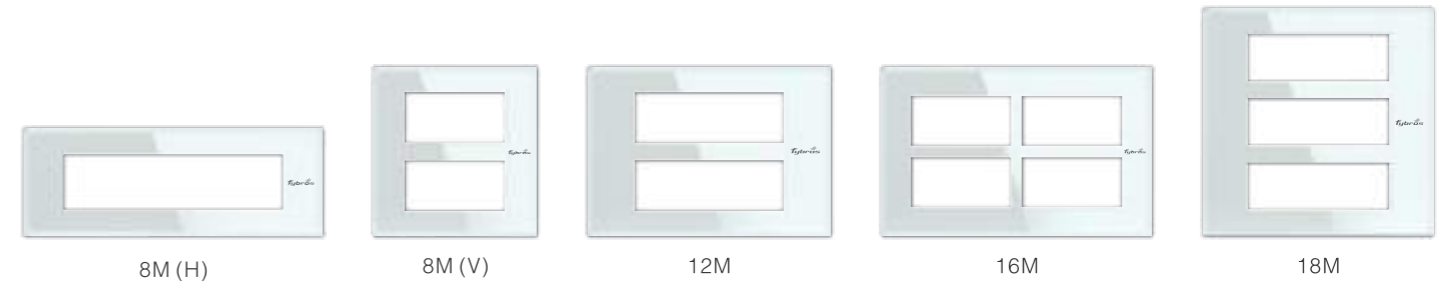

SERIES 9 MOUNTING FRAMES - HORIZONTAL & VERTICAL FOR FIXING (Dimensions in mm)

Module ⇨	2M	3M	4M	6M	8M (H)	8M (V)	12M	16M	18M
MRP ₹	71.00	86.00	100.00	147.00	183.00	183.00	235.00	270.00	317.00
PKG ⇨	15/450	15/450	15/300	15/300	10/200	10/200	10/120	10/120	10/80
CODE ⇨	S9 02 102	S9 03 103	S9 04 104	S9 06 105	S9 08 106	S9 08 107	S9 12 108	S9 16 110	S9 18 109

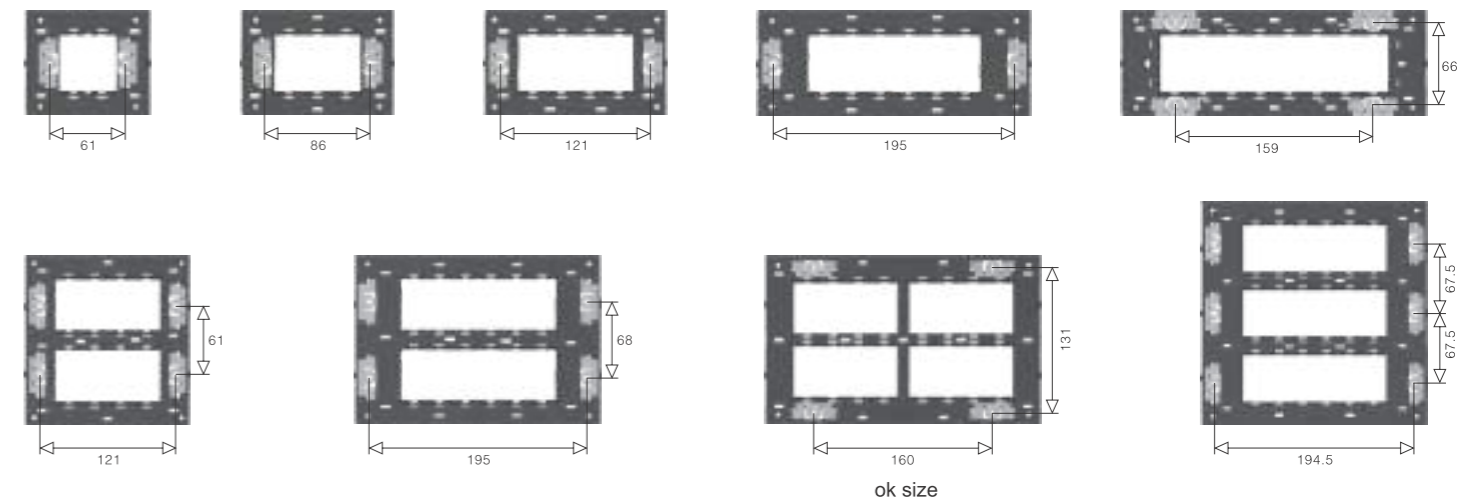

NEWLY INTRODUCED

SERIES 11 MODULAR PLATES WITH MOUNTING FRAMES - SUITABLE FOR METAL BOX															
Module ⇨	1M	2M	3M*	3M	4M*	4M	6M*	6M	8M*	8M	8M	12M	12M	16M	18M
							(H&V)**	(H&V)**	(H&V)**	(V)		(H&V)**			
Colours ↓	MRP	MRP	MRP	MRP	MRP	MRP	MRP	MRP	MRP	MRP	MRP	MRP	MRP	MRP	MRP
Natural	116.00	116.00	148.00	148.00	192.00	192.00	259.00	259.00	361.00	361.00	361.00	410.00	410.00	425.00	506.00
Metallic	164.00	164.00	205.00	205.00	271.00	271.00	357.00	357.00	459.00	459.00	459.00	573.00	573.00	583.00	705.00
Wood	190.00	190.00	243.00	243.00	329.00	329.00	428.00	428.00	544.00	544.00	544.00	699.00	699.00	730.00	852.00
PKG ⇨	10/500	10/500	10/400	10/400	10/400	10/400	10/200	10/200	10/200	10/200	10/200	05/120	05/120	05/90	05/80
CODE ⇨	S1101 31	S1102 32	S1103 33	S1103 45	S1104 34	S1104 35	S1106 36	S1106 37	S1108 38	S1108 39	S1108 40	S1112 41	S1112 42	S1116 43	S1118 44
SIZE (mm)	98x91	98x91	121x91	121x91	152x91	152x91	220x91	220x91	265x91	285x91	152x168	220x157	220x157	270x161	220x222

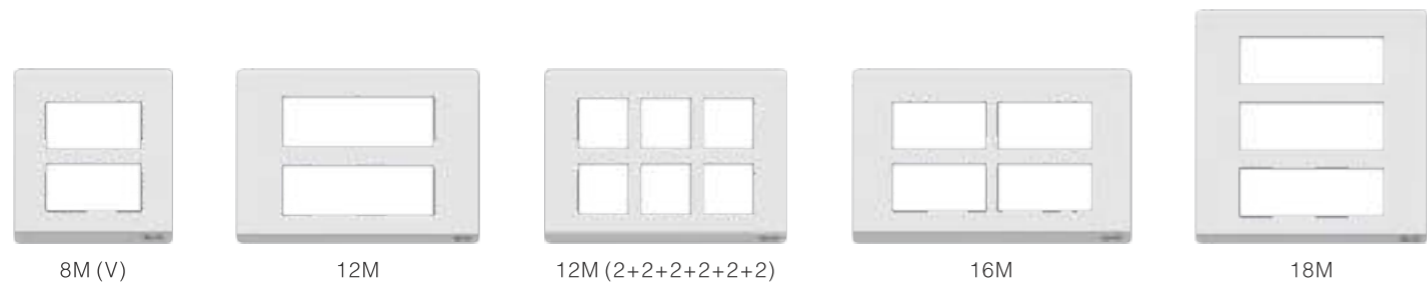
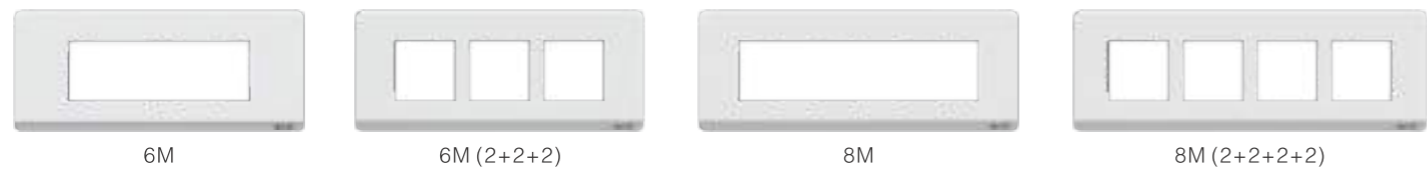

* without Partition Plates ** suitable for horizontal & vertical installation

SERIES 11 MOUNTING FRAMES - HORIZONTAL & VERTICAL FOR FIXING (Dimensions in mm)

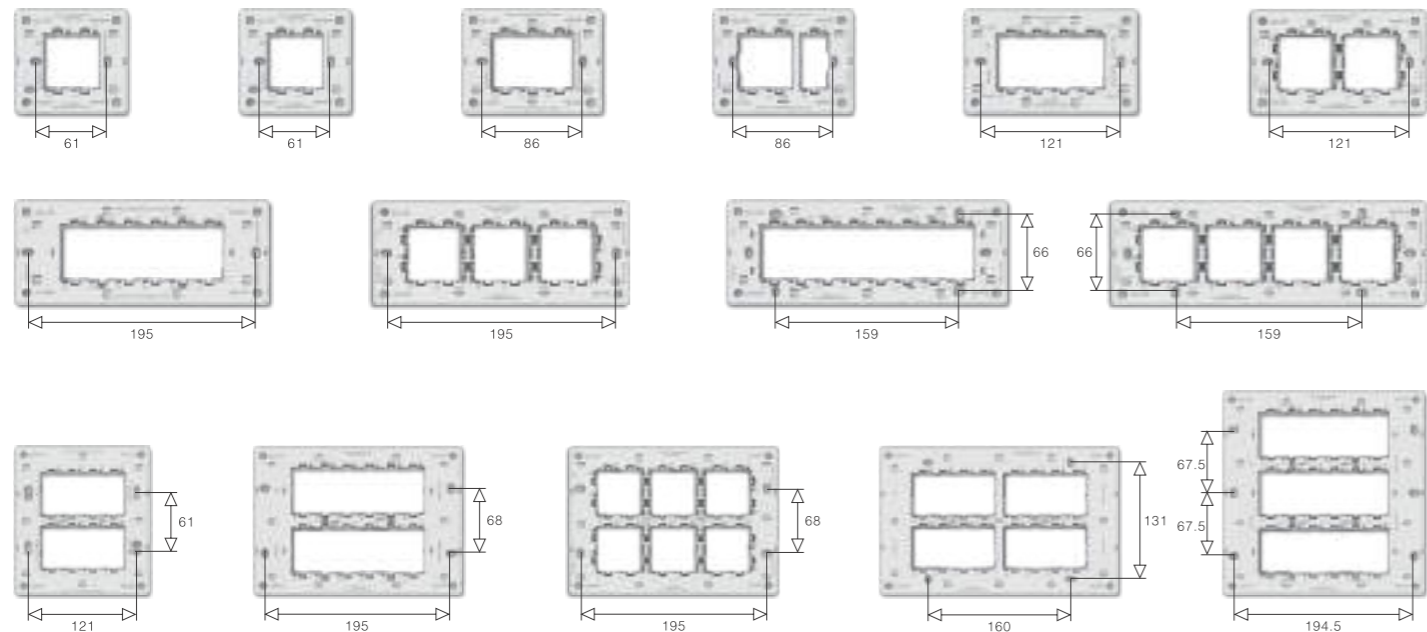

NEWLY INTRODUCED

SURFACE MOUNTING PLASTIC GANG BOXES (FIRE RESISTANT)										
Module ⇨	1&2M	3M	4M	6M	8M	8M(W/P)	8M(V)	12M	16M	18M
MRP	74.00	116.00	127.00	161.00	209.00	209.00	209.00	258.00	301.00	352.00
PKG ⇨	10 / 240	10 / 120	10 / 120	05 / 80	05 / 80	05 / 80	05 / 60	05 / 60	05 / 40	05 / 40
CODE ⇨	SB 02 22	SB 03 23	SB 04 24	SB 06 25	SB 08 26	SB 08 27	SB 08 28	SB 12 29	SB 16 30	SB 18 31
SIZE (WxHxL) mm	103x93x50	130x93x50	158x93x50	225x93x50	268x93x50	242x93x50	158x160x50	225x160x50	268x160x50	225x227x50



NUEVO METAL GANG BOXES NEW										
Module ⇨	1&2M	3M	4M	6M	8M	8M(V)	12M	16M	18M	
MRP	84.00	102.00	116.00	178.00	219.00	219.00	272.00	338.00	383.00	
PKG ⇨	20 / 120	20 / 120	20 / 120	10 / 80	10 / 80	05 / 60	05 / 40	05 / 40	05 / 40	
CODE ⇨	V5001	V5002	V5003	V5004	V5005	V5006	V5007	V5008	V5009	
SIZE (WxHxL) mm	76x50x74	105x50x74	139x52x73	210x50x74	230x54x77	212x60x200	209x60x130	231x60x144	212x60x200	



NEWLY INTRODUCED

SERIES 3
MODULAR PLATE

Natural

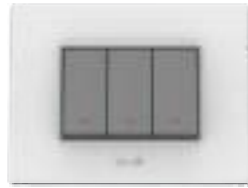

01- Pure White

Metallic



02- Emerald Chrome

Wood



03- Mapple Wood

Wood



04- Café Pine* (NEW)

SERIES 5
MODULAR PLATE

Natural



01- Snow White

Wood



02- Murky Wood

Metallic



03- Metalik Chrome



04- Velvet Grey



05- Onyx Black

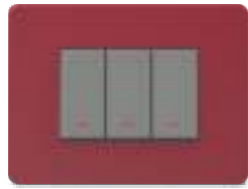

06- Cherry Red* (NEW)

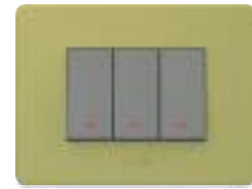

07- Aqua Green* (NEW)

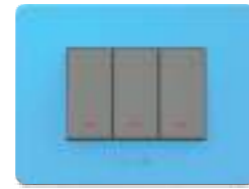

08- Aqua Blue* (NEW)

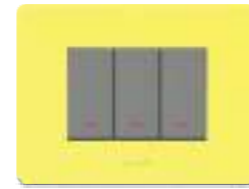

09- Majestic Yellow* (NEW)

SERIES 7
WOODEN PLATE

Natural



01- Shimmer White

Metallic



02- Alloy Chrome

Wood



03- Shady Wood

SERIES 9
GLASS PLATE

NEW

Glass



01- Chiffon White

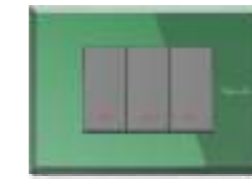

02- Forest Green

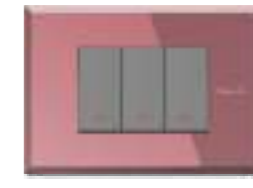

03- Ruby Wine



04- Coal Black



05- Frost White



06- Fossil Grey



07- Mocha Brown



08- Polished Chrome

Mirror Finish

SERIES 11
MODULAR PLATE

NEW

Natural



01- Dove White

Metallic



02- Lava Chrome



03- Khaki Mud



04- Rich Umber



05- Jade Black

Wood



06- Espresso Wood



07- Dark Walnut



- ① FPACE **PEARL WHITE** 4M PLATE WITH X3 SWITCH
- ② FPACE **MIAMI RED** 4M PLATE WITH X1 SWITCH
- ③ FPACE **HONEY SAPPHIRE** 4M PLATE WITH X2 SWITCH

Fpace
CRYSTAL PLATE

THE TANTALIZING ATTRACTION OF PURE GLASS IS NOW AN INTEGRAL PART OF YOUR HOME. THE MODULAR PLATES WITH SPECTACULAR GLASS FINISH ADD LOT OF GLOSS TO HOME DECOR. SUCCUMB TO THE SMOOTH CONTOURS AND THE ALLURING APPEAL. SO, SWITCH TO GLASS TO ENHANCE CLASS.

FAVIO
GEN. NEXT MODULAR SWITCHES





CODE	ITEM	MRP(Rs.)	PURE WHITE	METALLIC CHROME	PKG OUTER / MASTER
FAVIO 6AMP / 10AMP SWITCHES 240V~ (1Module)					
F1001	X1 One Way Switch	66.00	68.00	20 / 600	
F1002	X1 One Way Switch with Indicator (LED)	131.00	146.00	20 / 600	
F1003	X1 Two Way Switch	131.00	146.00	20 / 600	
F1004	X1 Bell Push Switch	145.00	161.00	20 / 600	
F1005	X1 Bell Push Switch with Indicator (LED)	164.00	182.00	20 / 600	

CODE	ITEM	MRP(Rs.)	PURE WHITE	METALLIC CHROME	PKG OUTER / MASTER
FAVIO 6AMP / 10AMP SWITCHES 240V~ (2Module)					
F1011	X1 One Way Switch	149.00	167.00	10 / 300	
F1012	X1 One Way Switch with Indicator (LED)	172.00	191.00	10 / 300	
F1013	X1 Two Way Switch	196.00	215.00	10 / 300	
F1014	X1 Bell Push Switch	179.00	201.00	10 / 300	
F1015	X1 Bell Push Switch with Indicator (LED)	203.00	226.00	10 / 300	

CODE	ITEM	MRP(Rs.)	PURE WHITE	METALLIC CHROME	PKG OUTER / MASTER
FAVIO 20AMP SWITCHES 240V~ (1Module)					
F1021	X1 One Way Switch	170.00	189.00	20 / 600	
F1022	X1 One Way Switch with Indicator (LED)	206.00	227.00	20 / 600	
F1023	X1 Two Way Switch	206.00	227.00	20 / 600	

CODE	ITEM	MRP(Rs.)	PURE WHITE	METALLIC CHROME	PKG OUTER / MASTER
FAVIO 20AMP SWITCHES 240V~ (2Module)					
F1031	X1 One Way Switch	220.00	242.00	10 / 300	
F1032	X1 One Way Switch with Indicator (LED)	240.00	267.00	10 / 300	
F1033	X1 Two Way Switch	265.00	294.00	10 / 300	

CODE	ITEM	MRP(Rs.)	PURE WHITE	METALLIC CHROME	PKG OUTER / MASTER
FAVIO 32AMP DP SWITCH 240V~ (2Module)					
F1040	X1 32A DP Switch with Indicator (LED)	362.00	400.00	10 / 300	

CODE	ITEM	MRP(Rs.)	PURE WHITE	METALLIC CHROME	PKG OUTER / MASTER
FAVIO 6AMP / 10AMP SWITCHES 240V~ (1Module)					
F1301	X3 One Way Switch	59.00	66.00	20 / 900	
F1302	X3 One Way Switch with Indicator (LED)	102.00	115.00	20 / 900	
F1303	X3 Two Way Switch	102.00	115.00	20 / 900	
F1304	X3 Bell Push Switch	117.00	129.00	20 / 900	
F1305	X3 Bell Push Switch with Indicator (LED)	135.00	148.00	20 / 900	

CODE	ITEM	MRP(Rs.)	PURE WHITE	METALLIC CHROME	PKG OUTER / MASTER
FAVIO 6AMP / 10AMP SWITCHES 240V~ (2Module)					
F1311	X3 One Way Switch	115.00	129.00	10 / 450	
F1312	X3 One Way Switch with Indicator (LED)	132.00	146.00	10 / 450	
F1313	X3 Two Way Switch	132.00	146.00	10 / 450	
F1314	X3 Bell Push Switch	140.00	155.00	10 / 450	
F1315	X3 Bell Push Switch with Indicator (LED)	160.00	173.00	10 / 450	

CODE	ITEM	MRP(Rs.)	PURE WHITE	METALLIC CHROME	PKG OUTER / MASTER
FAVIO 20AMP SWITCHES 240V~ (1Module)					
F1321	X3 One Way Switch	135.00	149.00	20 / 900	
F1322	X3 One Way Switch with Indicator (LED)	164.00	178.00	20 / 900	
F1323	X3 Two Way Switch	164.00	178.00	20 / 900	

CODE	ITEM	MRP(Rs.)	PURE WHITE	METALLIC CHROME	PKG OUTER / MASTER
FAVIO 20AMP SWITCHES 240V~ (2Module)					
F1331	X3 One Way Switch	162.00	179.00	10 / 450	
F1332	X3 One Way Switch with Indicator (LED)	184.00	199.00	10 / 450	
F1333	X3 Two Way Switch	214.00	242.00	10 / 450	

CODE	ITEM	MRP(Rs.)	PURE WHITE	METALLIC CHROME	PKG OUTER / MASTER
FAVIO 32AMP DP SWITCH 240V~ (2Module)					
F1340	X3 32A DP Switch with Indicator (LED)	273.00	305.00	10 / 300	

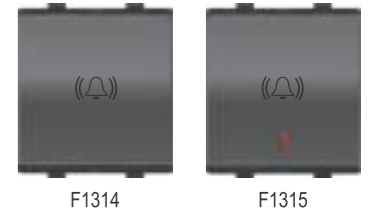

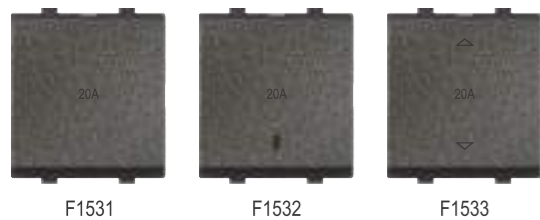

CODE	ITEM	MRP(Rs.)	PURE WHITE	METALLIC CHROME	PKG OUTER / MASTER
FAVIO 6AMP / 10AMP SWITCHES 240V~ (1Module)					
F1501	X5 One Way Switch	59.00	66.00	20 / 900	
F1502	X5 One Way Switch with Indicator (LED)	102.00	115.00	20 / 900	
F1503	X5 Two Way Switch	102.00	115.00	20 / 900	
F1504	X5 Bell Push Switch	117.00	129.00	20 / 900	
F1505	X5 Bell Push Switch with Indicator (LED)	135.00	148.00	20 / 900	

CODE	ITEM	MRP(Rs.)	PURE WHITE	METALLIC CHROME	PKG OUTER / MASTER
FAVIO 6AMP / 10AMP SWITCHES 240V~ (2Module)					
F1511	X5 One Way Switch	115.00	129.00	10 / 450	
F1512	X5 One Way Switch with Indicator (LED)	132.00	146.00	10 / 450	
F1513	X5 Two Way Switch	132.00	146.00	10 / 450	
F1514	X5 Bell Push Switch	140.00	155.00	10 / 450	
F1515	X5 Bell Push Switch with Indicator (LED)	160.00	173.00	10 / 450	

CODE	ITEM	MRP(Rs.)	PURE WHITE	METALLIC CHROME	PKG OUTER / MASTER
FAVIO 20AMP SWITCHES 240V~ (1Module)					
F1521	X5 One Way Switch	135.00	149.00	20 / 900	
F1522	X5 One Way Switch with Indicator (LED)	164.00	178.00	20 / 900	
F1523	X5 Two Way Switch	164.00	178.00	20 / 900	

CODE	ITEM	MRP(Rs.)	PURE WHITE	METALLIC CHROME	PKG OUTER / MASTER
FAVIO 20AMP SWITCHES 240V~ (2Module)					
F1531	X5 One Way Switch	162.00	179.00	10 / 450	
F1532	X5 One Way Switch with Indicator (LED)	184.00	199.00	10 / 450	
F1533	X5 Two Way Switch	214.00	242.00	10 / 450	

CODE	ITEM	MRP(Rs.)	PURE WHITE	METALLIC CHROME	PKG OUTER / MASTER
FAVIO 32AMP DP SWITCH 240V~ (2Module)					
F1540	X5 32A DP Switch with Indicator (LED)	280.00	312.00	10 / 300	

CODE	ITEM	MRP(Rs.)	PURE WHITE	METALLIC CHROME	PKG OUTER / MASTER
FAVIO 6AMP / 13AMP SOCKET 240V~					
F1041	6A 2 Pin Socket (1M) with safety shutter	121.00	135.00	20 / 900	
F1042	6A 2x1 Socket (2M) with safety shutter	129.00	147.00	10 / 450	
F1043	13A International Socket (2M) with safety shutter	237.00	265.00	20 / 600	
F1044	6A 3 Pin Socket (2M) with safety shutter	129.00	147.00	10 / 450	
F1046	6A 3 Pin Socket (2M) without safety shutter	119.00	143.00	10 / 450	
F1047	6A 2x1 Socket (2M) without safety shutter	119.00	143.00	10 / 450	

CODE	ITEM	MRP(Rs.)	PURE WHITE	METALLIC CHROME	PKG OUTER / MASTER
FAVIO 6&16AMP / 6&25AMP SOCKET 240V~ (2Module)					
F1048	6&16A Universal Socket with safety shutter	259.00	281.00	10 / 300	
F1049	6&25A Universal Socket with safety shutter	285.00	315.00	10 / 300	
F1131	6&16A Raised Socket with safety shutter	259.00	281.00	10 / 300	
F1132	6&25A Raised Socket with safety shutter	285.00	315.00	10 / 300	

CODE	ITEM	MRP(Rs.)	PURE WHITE	METALLIC CHROME	PKG OUTER / MASTER
FAVIO DIMMER 240V~					
F1051	Java Mini Dimmer (1M) 240V~ 50-60HZ 300-450W	339.00	378.00	20 / 600	
F1052	Java Medium Dimmer (2M) 240V~ 50-60HZ 300-450W	453.00	511.00	10 / 300	
F1053	Adora Mini Dimmer (1M) 240V~ 50-60HZ 300-450W	339.00	378.00	20 / 600	
F1054	Adora Medium Dimmer (2M) 240V~ 50-60HZ 300-450W	453.00	511.00	10 / 300	

CODE	ITEM	MRP(Rs.)	PURE WHITE	METALLIC CHROME	PKG OUTER / MASTER
FAVIO FAN REGULATOR					
F1055	Java Mini Step Regulator (1M) 4 Step, 240V~ 50-60HZ	486.00	550.00	20 / 600	
F1056	Java Medium Step Regulator Half Rotary (2M) 5 Step, 240V~ 50-60HZ	528.00	586.00	10 / 300	
F1057	Java Medium Step Regulator Full Rotary (2M) 5 Step, 240V~ 50-60HZ	528.00	586.00	10 / 300	

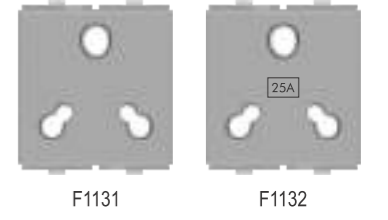
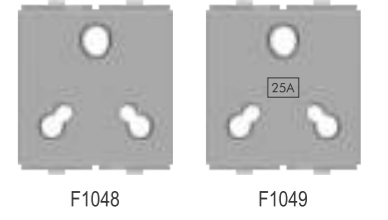
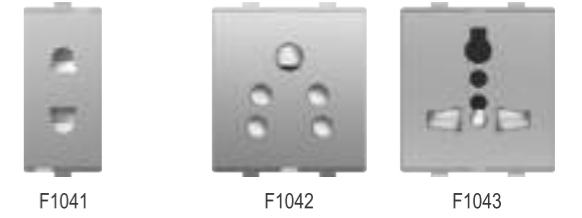



CODE	ITEM	MRP(Rs.)	PURE WHITE	METALLIC CHROME	PKG OUTER / MASTER
FAVIO FAN REGULATOR					
F1058	Adora Mini Step Regulator Full Rotary (1M) 4 Step, 240V~ 50-60HZ	486.00	550.00	20 / 600	
F1059	Adora Medium Step Regulator Full Rotary (2M) 5 Step, 240V~ 50-60HZ	528.00	586.00	10 / 300	
F1060	Flare Medium Step Regulator Full Rotary (2M) 5 Step, 240V~ 50-60HZ	528.00	585.00	10 / 300	



CODE	ITEM	MRP(Rs.)	PURE WHITE	METALLIC CHROME	PKG OUTER / MASTER
FAVIO MOTOR STARTER 240V~ 50-60HZ (2Module)					
F1064	25A Motor Starter Switch	669.00	731.00	10 / 300	



CODE	ITEM	MRP(Rs.)	PURE WHITE	METALLIC CHROME	PKG OUTER / MASTER
FAVIO TV SOCKET/RJ-11 TELEPHONE JACKS/EDP SOCKET					
F1071	TV Socket Coaxial (1M) 40-862 mhz socket	151.00	167.00	40 / 1200	
F1072	Telephone jack - RJ 11 (1M)	164.00	181.00	40 / 1200	
F1073	EDP Socket Outlet - RJ 45 (5e) (1M) Universal wiring t568a, Insulating-piercing terminal	285.00	313.00	20 / 900	
F1074	EDP Socket Outlet - RJ 45 (6e) (1M) Universal wiring t568a, Insulating-piercing terminal	717.00	784.00	20 / 900	



CODE	ITEM	MRP(Rs.)	PURE WHITE	METALLIC CHROME	PKG OUTER / MASTER
FAVIO SINGLE POLE MCBs 240 / 450V~ (1Module)					
F1081	6A SP MCB	330.00	361.00	20 / 600	
F1082	10A SP MCB	330.00	361.00	20 / 600	
F1083	16A SP MCB	330.00	361.00	20 / 600	
F1084	20A SP MCB	330.00	361.00	20 / 600	
F1085	25A SP MCB	330.00	361.00	20 / 600	
F1086	32A SP MCB <small>(240 / 450V~50-60hz 1.5ka breaking capacity)</small>	330.00	361.00	20 / 600	

CODE	ITEM	MRP(Rs.)	PURE WHITE	METALLIC CHROME	PKG OUTER / MASTER
FAVIO DOUBLE POLE MCBs 240 / 450V~ (2Module)					
F1091	6A DP MCB	659.00	719.00	10 / 300	
F1092	10A DP MCB	659.00	719.00	10 / 300	
F1093	16A DP MCB	659.00	719.00	10 / 300	
F1094	20A DP MCB	659.00	719.00	10 / 300	
F1095	25A DP MCB	659.00	719.00	10 / 300	
F1096	32A DP MCB <small>(240 / 450V~50-60hz 1.5ka breaking capacity)</small>	659.00	719.00	10 / 300	

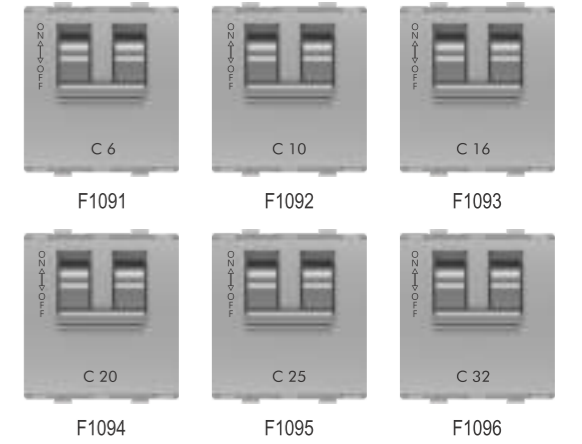

CODE	ITEM	MRP(Rs.)	PURE WHITE	METALLIC CHROME	PKG OUTER / MASTER
FAVIO INDICATOR / BLANK MODULE / KITKAT (1Module)					
F1101	Indicator with led & red diffuser	104.00	119.00	20 / 600	
F1102	Blank Module	23.00	27.00	50 / 2000	
F1103	kitkat Fuse <small>(10Amp/16Amp) with miniature fuse</small>	200.00	222.00	20 / 600	
F1104	I-Light Indicator with led & red diffuser	101.00	116.00	40 / 1200	



CODE	ITEM	MRP(Rs.)	PURE WHITE	METALLIC CHROME	PKG OUTER / MASTER
FAVIO STEP MARKER / FOOT LIGHT 240V~ 50-60Hz					
F1105	Night Lamp (2M) with high-efficiency 1.0W LED	426.00	487.00	10 / 300	
F1106	Foot Light - LED (2M) with high-efficiency 1.0W LED	426.00	487.00	10 / 300	
F1107	Foot Light - LED (4M) with high-efficiency 2.0W LED	838.00	924.00	05 / 120	
F1108	Step Marker (3M) with high-efficiency 3.5W LED	684.00	758.00	10 / 100	

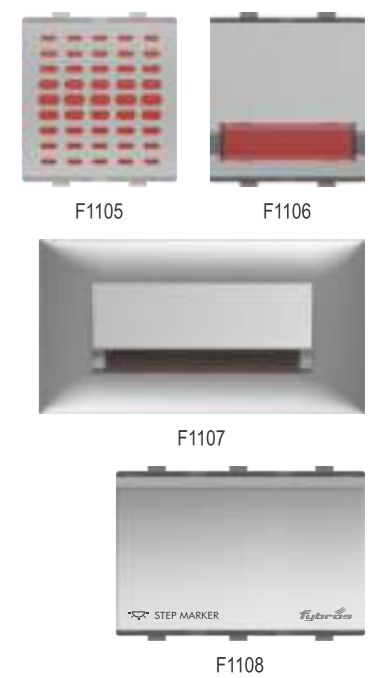

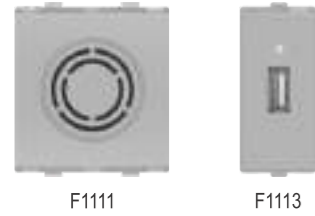

CODE	ITEM	MRP(Rs.)	PURE WHITE	METALLIC CHROME	PKG OUTER / MASTER
FAVIO USB CHARGER / ELECTRONIC BUZZER 240V~					
F1111	Electronic Multi Tune Buzzer (2M)	434.00	480.00		10 / 300
F1113	USB Charger (1M) with Usb port & Ind. Input 240V~ 50-60Hz Output-5V DC, 2A	769.00	870.00		20 / 600

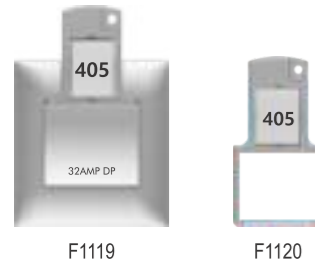

CODE	ITEM	MRP(Rs.)	PURE WHITE	METALLIC CHROME	PKG OUTER / MASTER
FAVIO 32AMP. DP KEY TAG SWITCHES					
F1119	32AMP. DP Main Switch with key tag	618.00	669.00		05 / 100
F1120	Key Tag Only	127.00	136.00		100 / 1000

FLORENZA MODULAR PLATES WITH MOUNTING FRAMES

Module ⇨	1M	2M	3M	3M*	4M	4M*	6M	6M*	8M	8M*	8M	12M	12M*	16M	18M
						(H&V)**		(H&V)**		(H&V)**	(V)		(H&V)**		
Colour ↓	MRP	MRP	MRP	MRP	MRP	MRP	MRP	MRP	MRP	MRP	MRP	MRP	MRP	MRP	MRP
Natural	95.00	95.00	117.00	117.00	144.00	144.00	207.00	207.00	260.00	260.00	260.00	298.00	298.00	339.00	380.00
Metallic	158.00	158.00	206.00	206.00	253.00	253.00	352.00	352.00	436.00	436.00	436.00	511.00	511.00	572.00	595.00
Wood	207.00	207.00	284.00	284.00	352.00	352.00	483.00	483.00	665.00	665.00	665.00	686.00	686.00	752.00	802.00
PKG ⇨	10/500	10/500	10/400	10/400	10/400	10/400	05/200	05/200	05/200	05/200	05/200	05/120	05/120	05/90	05/80
CODE ⇨	F2001	F2002	F2003	F2004	F2005	F2006	F2007	F2008	F2009	F2010	F2011	F2012	F2013	F2014	F2015
SIZE (mm)	93x93	93x93	124x93	124x93	159x93	159x93	225x93	225x93	245x93	270x93	159x168	225x168	225x168	270x168	225x225

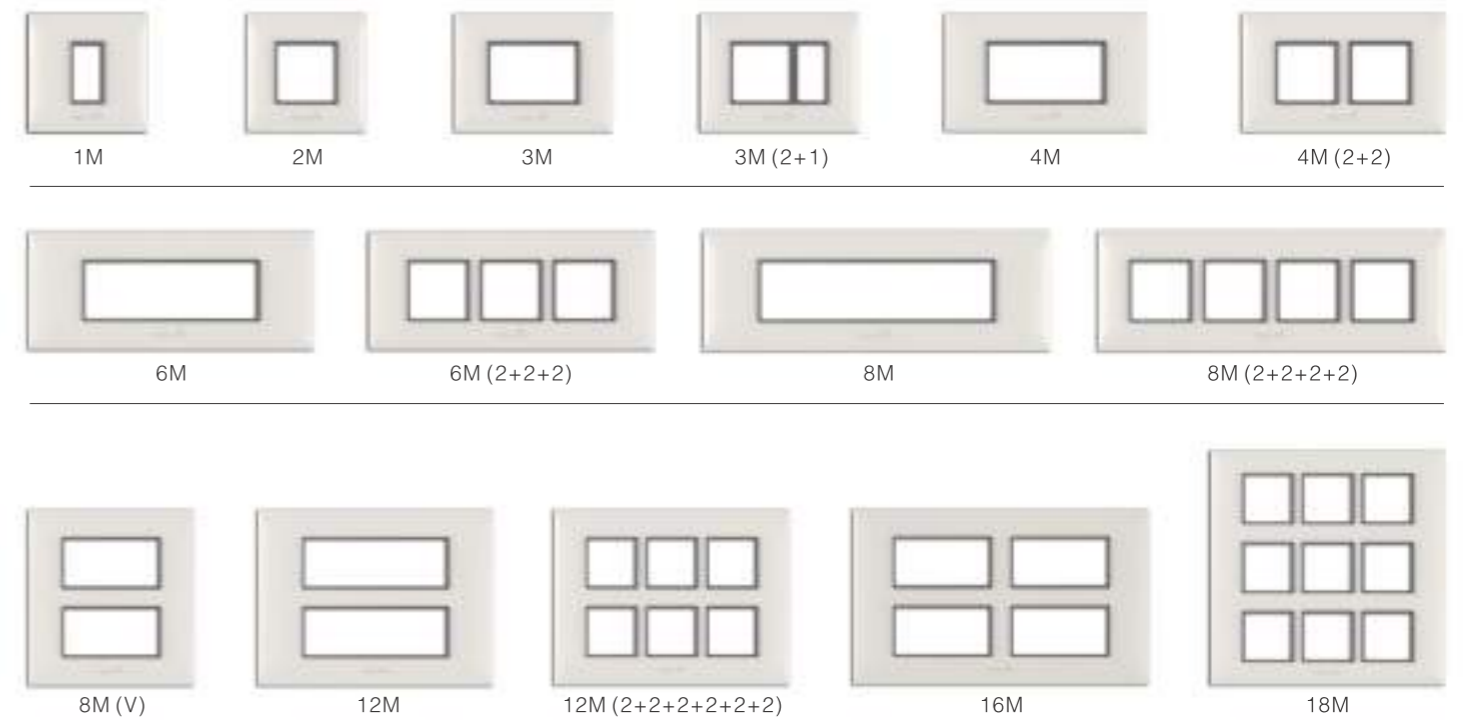

* with Partition Plates ** suitable for horizontal & vertical installation

FLORENZA MOUNTING FRAMES - HORIZONTAL & VERTICAL DISTANCE FOR SCREWING (dimensions in mm)

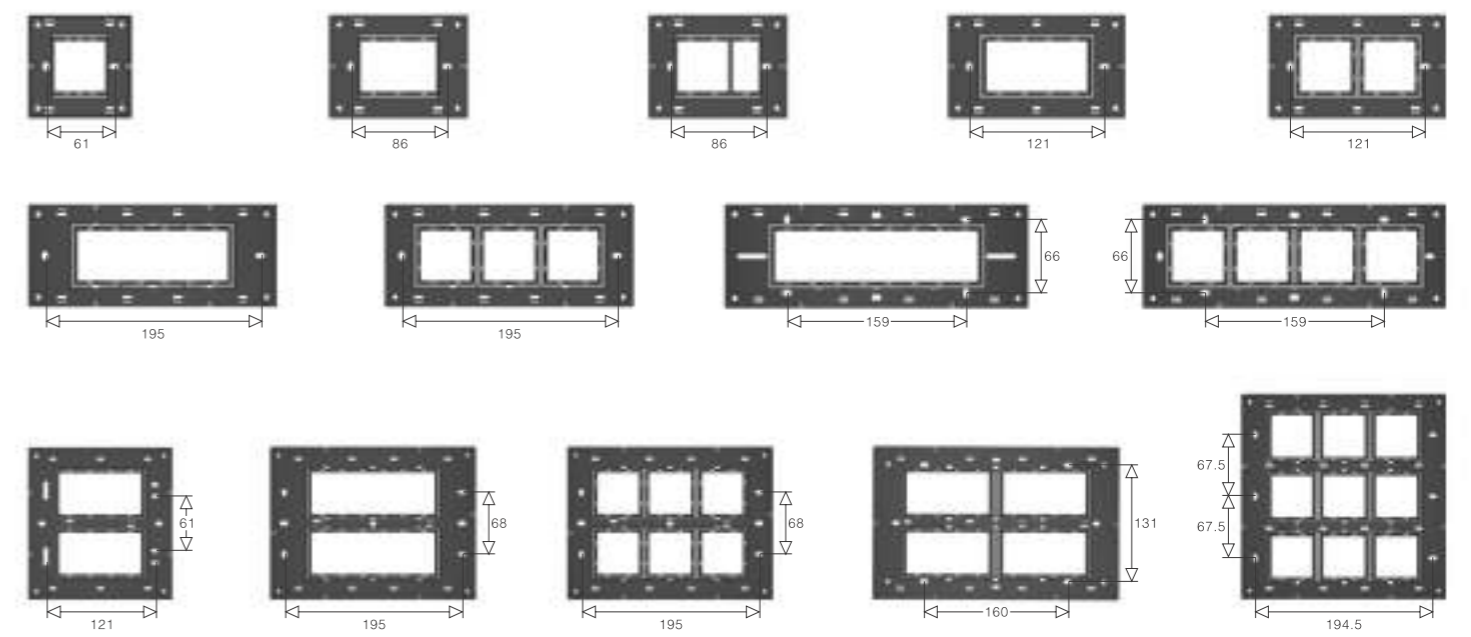

FUSION MODULAR PLATES WITH MOUNTING FRAMES

Module	1M	2M	3M	3M*	4M	4M*	6M	6M*	8M	8M*	8M	12M	12M*	16M	18M
					(H&V)**	(H&V)**	(H&V)**	(H&V)**	(V)	(H&V)**		(H&V)**			
Colour ↓	MRP	MRP	MRP	MRP	MRP	MRP	MRP	MRP	MRP	MRP	MRP	MRP	MRP	MRP	MRP
Natural	95.00	95.00	117.00	117.00	144.00	144.00	207.00	207.00	260.00	260.00	260.00	298.00	298.00	339.00	380.00
Metallic	158.00	158.00	206.00	206.00	253.00	253.00	352.00	352.00	436.00	436.00	436.00	511.00	511.00	572.00	595.00
PKG ⇨	10/500	10/500	10/400	10/400	10/400	10/400	05/200	05/200	05/200	05/200	05/200	05/120	05/120	05/90	05/80
CODE ⇨	F3001	F3002	F3003	F3004	F3005	F3006	F3007	F3008	F3009	F3010	F3011	F3012	F3013	F3014	F3015
SIZE (mm)	93x93	93x93	124x93	124x93	159x93	159x93	225x93	225x93	245x93	270x93	159x168	225x168	225x168	270x168	225x225

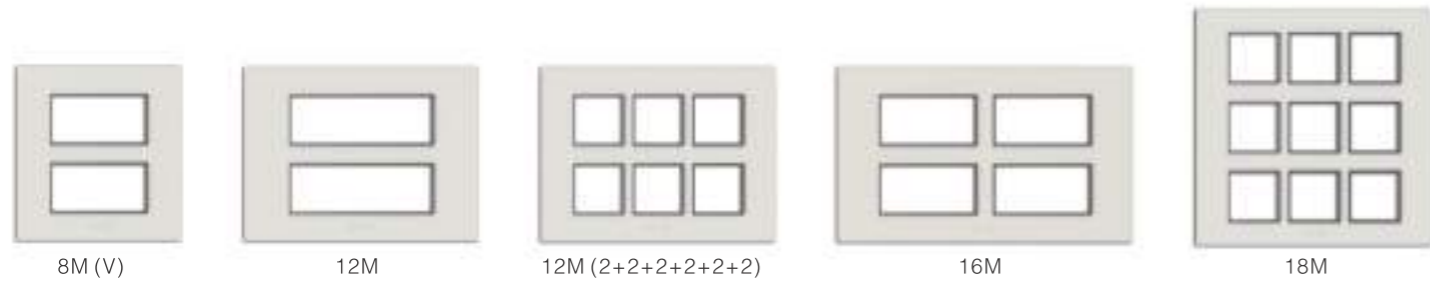
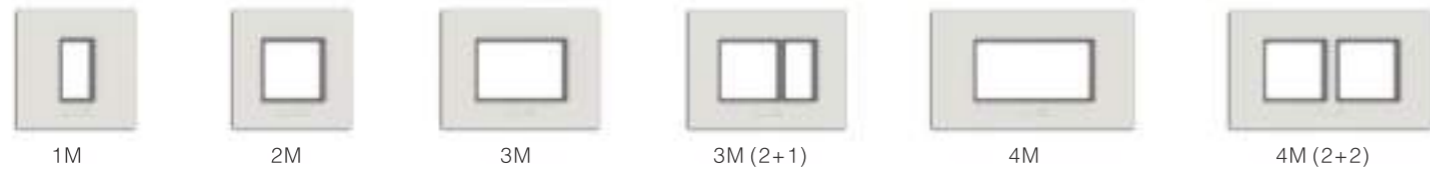

* with Partition Plates ** suitable for horizontal & vertical installation

FUSION MOUNTING FRAMES - HORIZONTAL & VERTICAL DISTANCE FOR SCREWING (dimensions in mm)

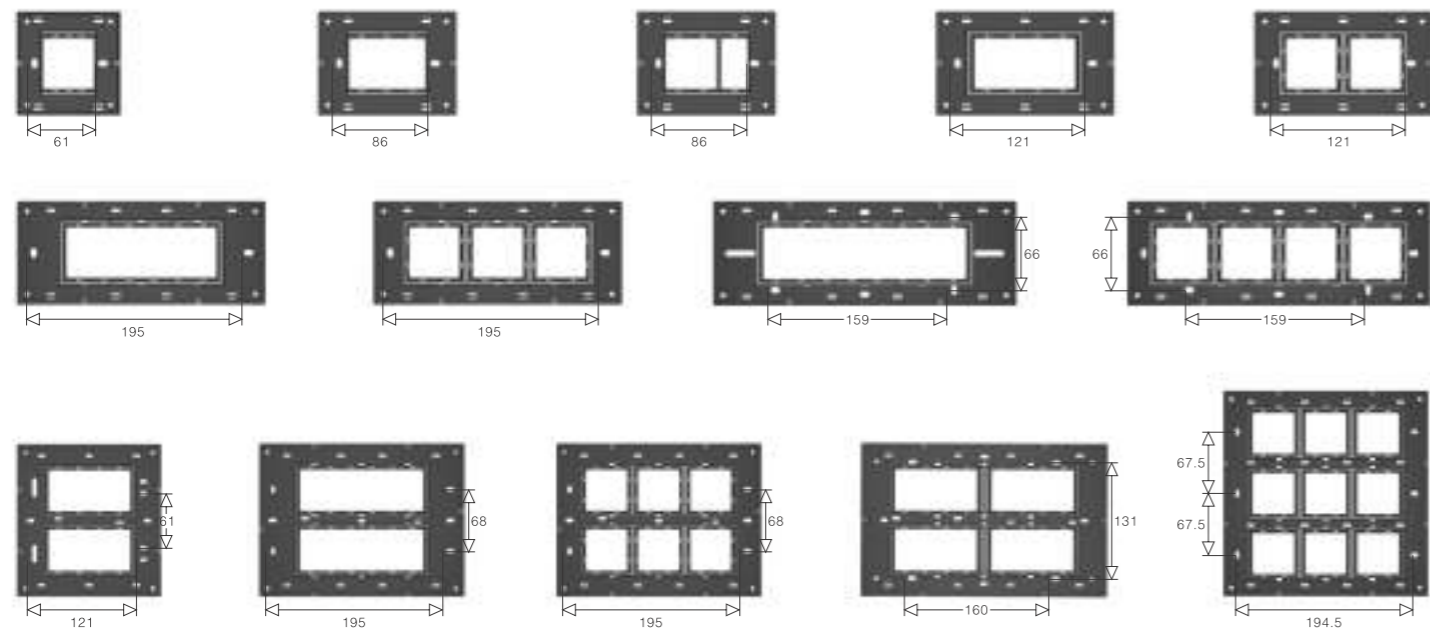

F-PACE MODULAR COVER PLATES

Module	1M	2M	3M	4M	6M	8M	8M (V)	12M	16M	18M
Colours	MRP	MRP	MRP	MRP	MRP	MRP	MRP	MRP	MRP	MRP
Leather with Frame	259.00	259.00	336.00	409.00	507.00	641.00	641.00	777.00	-	926.00
Glass without Frame	508.00	508.00	726.00	989.00	1341.00	1478.00	1478.00	1782.00	1960.00	2192.00
PKG	10/200	10/200	10/200	10/150	05/100	05/100	05/100	05/75	05/40	05/40
CODE	F4001	F4002	F4003	F4004	F4005	F4006	F4007	F4008	F4009	F4010
SIZE (mm)	93x93	93x93	124x93	159x93	225x93	245x93	159x168	225x168	270x168	225x225

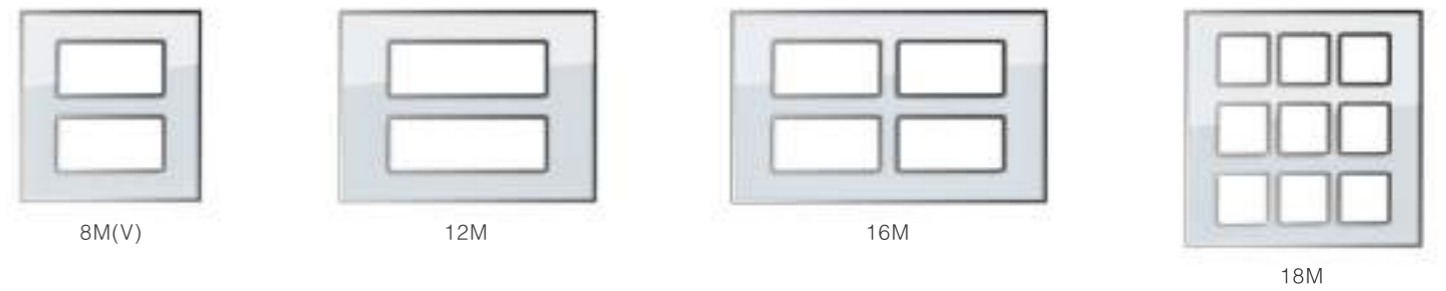
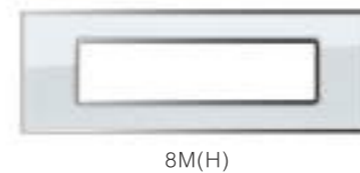

F-PACE MOUNTING FRAMES - HORIZONTAL & VERTICAL DISTANCE FOR SCREWING (dimensions in mm)

Module	2M	3M	4M	6M	8M	8M(V)	12M	16M	18M
MRP	58.00	70.00	80.00	120.00	148.00	148.00	190.00	228.00	259.00
PKG ⇨	25/500	25/400	25/400	20/200	20/200	20/200	20/120	20/120	10/80
CODE ⇨	F5002	F5003	F5004	F5005	F5006	F5007	F5008	F5009	F5010

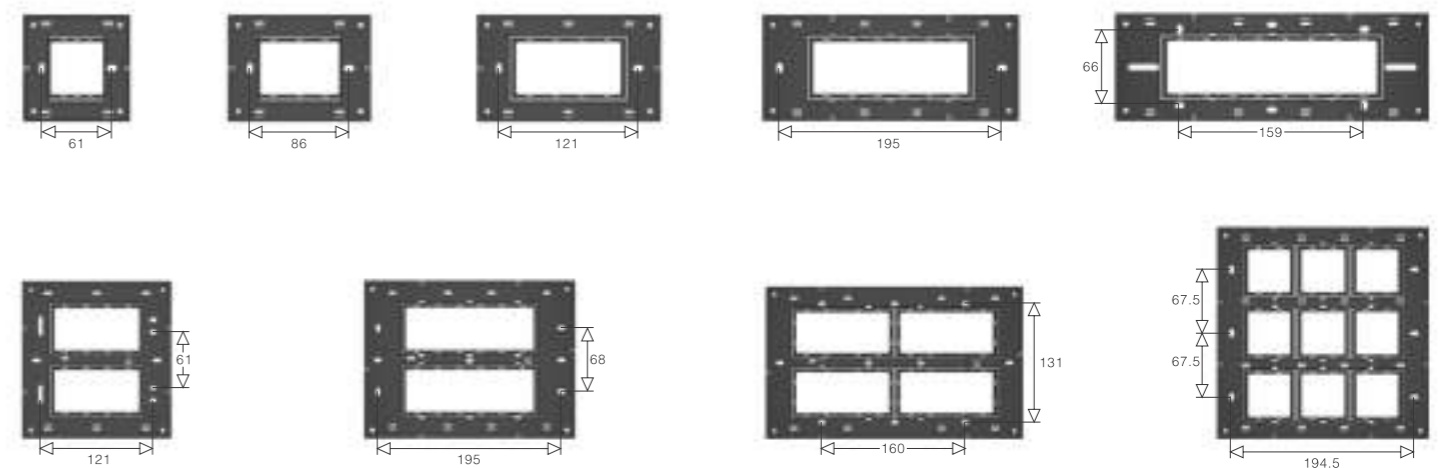

F-WOOD MODULAR PLATES WITH MOUNTING FRAMES													
Module ⇨	1M	2M	3M	4M	6M	8M	10M	12M-H	12M-V	16M	18M	20M	24M
Colours ↓	MRP	MRP	MRP	MRP	MRP	MRP	MRP	MRP	MRP	MRP	MRP	MRP	MRP
Natural	109.00	109.00	134.00	165.00	234.00	294.00	312.00	336.00	336.00	383.00	427.00	548.00	658.00
Metallic	168.00	168.00	218.00	262.00	362.00	445.00	485.00	520.00	520.00	579.00	608.00	733.00	879.00
Wood	219.00	219.00	295.00	362.00	491.00	607.00	636.00	694.00	694.00	759.00	808.00	948.00	1064.00
PKG ⇨	10/480	10/480	10/360	10/240	10/240	10/240	05/200	05/100	05/180	05/180	05/100	05/120	05/100
CODE ⇨	F7001	F7002	F7003	F7004	F7005	F7006	F7007	F7008	F7009	F7010	F7011	F7012	F7013
SIZE (mm)	115x115	115x115	130x115	180x115	220x115	270x115	315x115	392x115	220x180	272x180	270x220	320x180	320x220

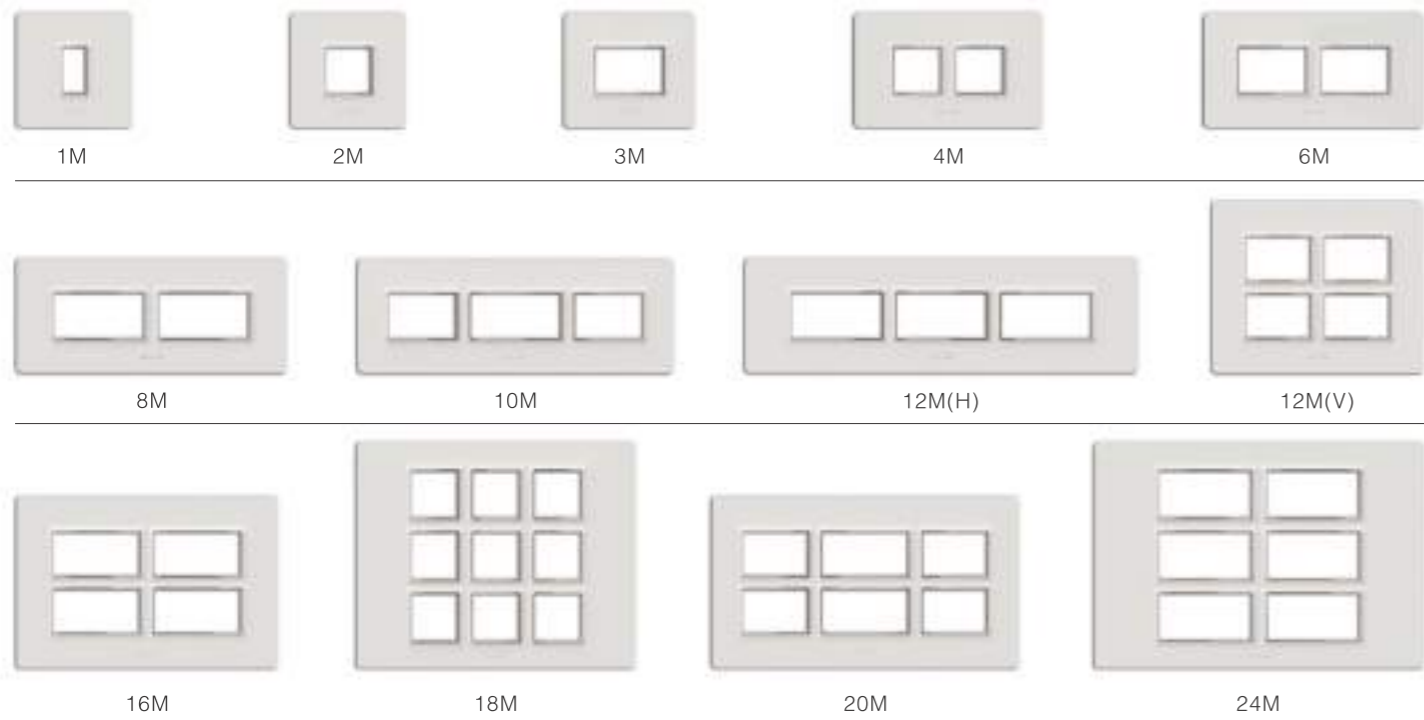

F-WOOD MOUNTING FRAMES - HORIZONTAL & VERTICAL DISTANCE FOR SCREWING (dimensions in mm)

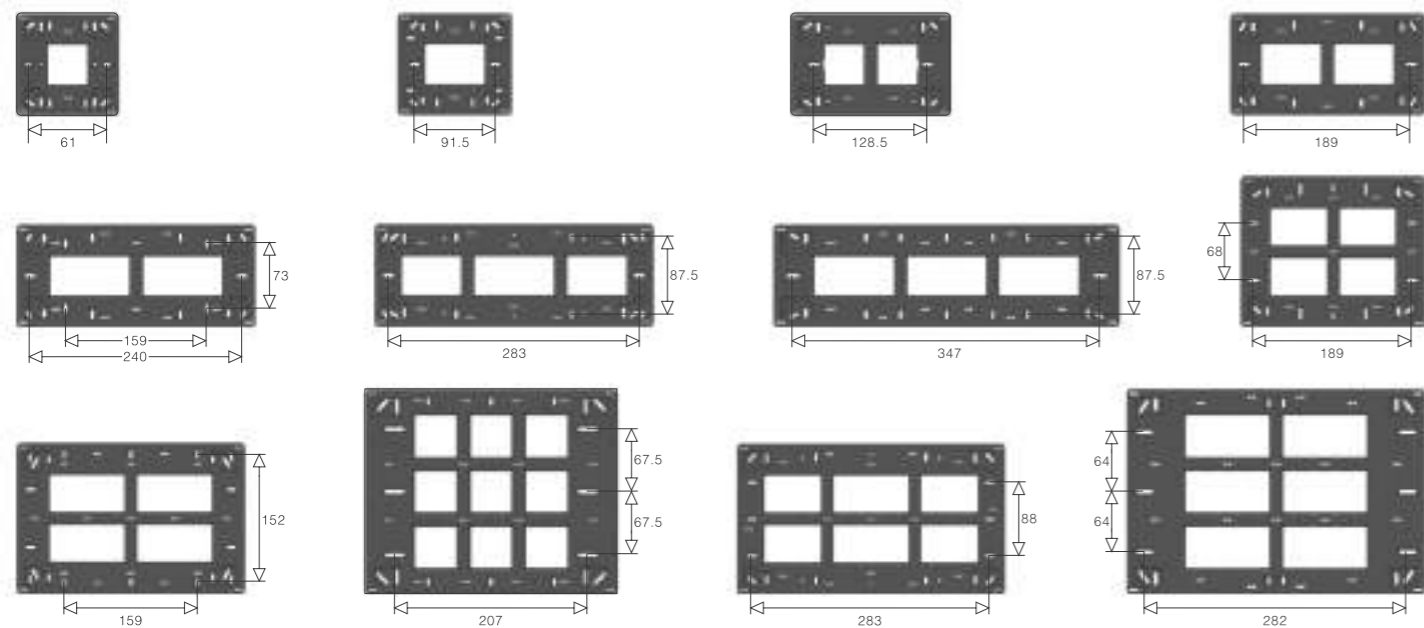

FLARE MODULAR PLATES WITH MOUNTING FRAMES										
Module ⇨	1M	2M	3M	4M	6M	8M	8M(V)	12M	16M	18M
Colour ↓	MRP	MRP	MRP	MRP	MRP	MRP	MRP	MRP	MRP	MRP
Natural	100.00	100.00	122.00	150.00	215.00	272.00	272.00	311.00	353.00	396.00
Metallic	166.00	166.00	218.00	267.00	369.00	456.00	456.00	536.00	599.00	623.00
Wood	218.00	218.00	299.00	369.00	505.00	696.00	696.00	718.00	786.00	839.00
PKG ⇨	10/500	10/500	10/400	10/400	10/200	10/200	10/200	05/120	05/90	05/80
CODE ⇨	F9001	F9002	F9003	F9004	F9005	F9006	F9007	F9008	F9009	F9010
SIZE (mm)	94x90	94x90	118x90	146x90	220x90	260x90	152x158	220x158	260x158	220x220



FLARE MOUNTING FRAMES - HORIZONTAL & VERTICAL DISTANCE FOR SCREWING (dimensions in mm)

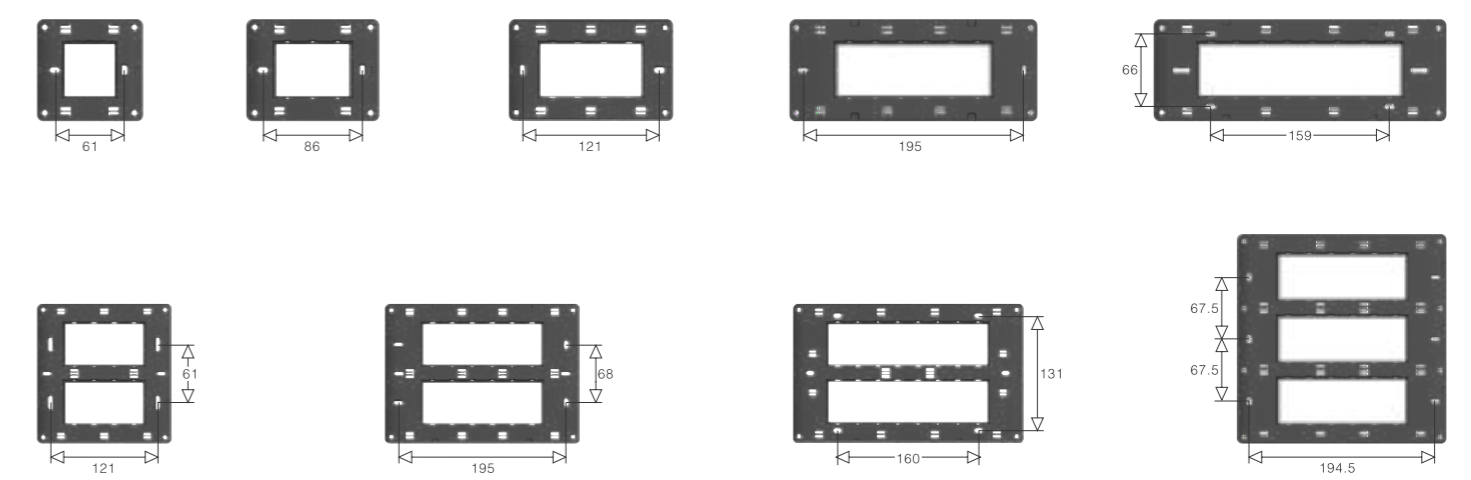

Natural



01 - Glacier White



02 - Amber Ivory

Metallic



06 - Metallic Chrome



07 - Metallic Silver

Wood



11 - American Wenge

FUSION
ULTRA SLIM PLATE

Natural



01 - Glacier White

Metallic



06 - Metallic Chrome



07 - Matt Black

Leather



07 - Oxford Black



08 - Desert Brown

Glass



15 - Pearl White



16 - Kasz Black



17 - Miami Red



18 - Honey Sapphire

F-WOOD
MODULAR PLATE

Natural



01 - Glacier White

Metallic



02 - Mercury Chrome

Wood



03 - Spanish Walnut

FLARE
MODULAR PLATE

Natural



01 - Mint White

Metallic



06 - Metallic Bronze



07 - Mineral Chrome



08 - Black Sapphire

Wood



11 - Brown OAK

Note: Colours shown may not match actual product colours due to printing limitations.

WOOD~em
MODULAR SERIES



AIR **ITALIAN WALNUT** 6M PLATE
13 AMP INTERNATIONAL SOCKET, RAZE ONE WAY SWITCH WITH INDICATOR 1M AND CRYSTAL MEDIUM DIMMER 2M



AIR
MODULAR PLATES

A CLASSICAL CREATION, DISPLAYING A SMOOTH, GLOSSY FRONTAGE WITH BEVELLED EDGES AND A DEMEANOUR THAT'S SOPHISTICATED YET WARM AND INVITING. THE ELEGANTLY SHAPED CORNERS ABSORB LIGHT IN A MANNER THAT ADDS DEPTH AND CHARACTER TO THE SWITCHES. AVAILABLE IN CLASSIC WOOD FINISH, THESE MODULAR PLATES ARE PERFECT ART OBJECTS FOR THE WALLS.

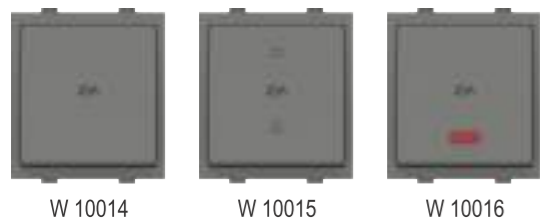

CODE	ITEM	MRP(Rs.)	PURE WHITE	METALLIC CHROME/BLACK	PKG OUTER / MASTER
WOOD-em 10 Amp. RAZE SWITCHES					
W 10001	1 Way Switch		48.00	61.00	20 / 1200
W 10002	2 Way Switch		76.00	89.00	20 / 1200
W 10003	1 Way Switch with Indicator		80.00	93.00	20 / 1200
W 10004	Bell Push		80.00	93.00	20 / 1200
W 10005	Bell Push with Indicator		88.00	99.00	20 / 1200

WOOD-em 10 Amp. RAZE GAMA SWITCHES					
W 10006	1 Way Switch		83.00	102.00	10 / 450
W 10007	2 Way Switch		95.00	115.00	10 / 450
W 10008	1 Way Switch with Indicator		95.00	115.00	10 / 450
W 10009	Bell Push		95.00	115.00	10 / 450
W 10010	Bell Push with Indicator		102.00	122.00	10 / 450

WOOD-em 20 Amp. RAZE SWITCHES					
W 10011	1 Way Switch		89.00	96.00	20 / 1200
W 10012	2 Way Switch		109.00	122.00	20 / 1200
W 10013	1 Way Switch with Indicator		105.00	110.00	20 / 1200
W 10067	1 Way Switch (Porcelain)		87.00	96.00	10 / 600

WOOD-em 20 Amp. RAZE GAMA SWITCHES					
W 10014	1 Way Switch		115.00	135.00	10 / 450
W 10015	2 Way Switch		122.00	141.00	10 / 450
W 10016	1 Way Switch with Indicator		122.00	141.00	10 / 450

WOOD-em RAZE POWER SWITCHES					
W 10018	32 Amp. 1 Way DP Switch with Indicator (Heavy Duty Double Pole Main Switch)		230.00	250.00	10 / 450

CODE	ITEM	MRP(Rs.)	PURE WHITE	METALLIC CHROME/BLACK	PKG OUTER / MASTER
WOOD-em 10 Amp. PLANA SWITCHES					
W 90001	1 Way Switch		58.00	70.00	20 / 1200
W 90002	2 Way Switch		83.00	96.00	20 / 1200
W 90003	1 Way Switch with Indicator		88.00	101.00	20 / 1200
W 90004	Bell Push		88.00	101.00	20 / 1200
W 90005	Bell Push with Indicator		96.00	109.00	20 / 1200

WOOD-em 10 Amp. PLANA GAMA SWITCHES					
W 90006	1 Way Switch		95.00	115.00	10 / 450
W 90016*	2 Way Switch (New)		109.00	128.00	10 / 450
W 90007	1 Way Switch with Indicator		109.00	128.00	10 / 450
W 90008	Bell Push with Indicator		115.00	135.00	10 / 450

WOOD-em 20 Amp. PLANA SWITCHES					
W 90009	1 Way Switch		99.00	104.00	20 / 1200
W 90010	2 Way Switch		116.00	130.00	20 / 1200
W 90011	1 Way Switch with Indicator		112.00	117.00	20 / 1200

WOOD-em 20 Amp. PLANA GAMA SWITCHES					
W 90012	1 Way Switch		127.00	145.00	10 / 450
W 90013	2 Way Switch		135.00	154.00	10 / 450
W 90014	1 Way Switch with Indicator		135.00	154.00	10 / 450

WOOD-em PLANA POWER SWITCHES					
W 90015	32 Amp. 1 Way DP Switch with Indicator (Heavy Duty Double Pole Main Switch)		254.00	273.00	10 / 450



* NEWLY INTRODUCED

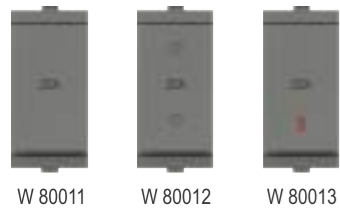

CODE	ITEM	MRP(Rs.)	PURE WHITE	METALLIC CHROME/BLACK	PKG OUTER / MASTER
WOOD-em 10 Amp. AURA SWITCHES					
W 80001	1 Way Switch	58.00	78.00	20 / 1200	
W 80002	2 Way Switch	83.00	102.00	20 / 1200	
W 80003	1 Way Switch with Indicator	88.00	108.00	20 / 1200	
W 80004	Bell Push	88.00	108.00	20 / 1200	
W 80005	Bell Push with Indicator	96.00	114.00	20 / 1200	
WOOD-em 10 Amp. AURA GAMA SWITCHES					
W 80006	1 Way Switch	95.00	122.00	10 / 450	
W 80007	1 Way Switch with Indicator	109.00	133.00	10 / 450	
W 80008	Bell Push with Indicator	115.00	139.00	10 / 450	
WOOD-em 20 Amp. AURA SWITCHES					
W 80011	1 Way Switch	99.00	111.00	20 / 1200	
W 80012	2 Way Switch	116.00	138.00	20 / 1200	
W 80013	1 Way Switch with Indicator	112.00	131.00	20 / 1200	
WOOD-em 20 Amp. AURA GAMA SWITCHES					
W 80014	1 Way Switch	127.00	149.00	10 / 450	
W 80015	2 Way Switch	135.00	158.00	10 / 450	
W 80016	1 Way Switch with Indicator	135.00	158.00	10 / 450	
WOOD-em AURA POWER SWITCHES					
W 80018	32 Amp. 1 Way DP Switch with Indicator (Heavy Duty Double Pole Main Switch)	254.00	279.00	10 / 450	

CODE	ITEM	MRP(Rs.)	PURE WHITE	METALLIC CHROME/BLACK	PKG OUTER / MASTER
WOOD-em 10 Amp. SLIM SWITCHES					
W 90051	1 Way Switch	66.00	80.00	20 / 1200	
W 90052	2 Way Switch	93.00	106.00	20 / 1200	
W 90053	1 Way Switch with Indicator	98.00	111.00	20 / 1200	
W 90054	Bell Push	98.00	111.00	20 / 1200	
W 90055	Bell Push with Indicator	109.00	122.00	20 / 1200	
WOOD-em 10 Amp. SLIM GAMA SWITCHES					
W 90056	1 Way Switch	105.00	125.00	10 / 450	
W 90057	1 Way Switch with Indicator	118.00	138.00	10 / 450	
W 90058	Bell Push with Indicator	123.00	142.00	10 / 450	
WOOD-em 20 Amp. SLIM SWITCHES					
W 90059	1 Way Switch	104.00	115.00	20 / 1200	
W 90060	2 Way Switch	129.00	142.00	20 / 1200	
W 90061	1 Way Switch with Indicator	123.00	135.00	20 / 1200	
WOOD-em 20 Amp. SLIM GAMA SWITCHES					
W 90062	1 Way Switch	137.00	155.00	10 / 450	
W 90063	2 Way Switch	144.00	163.00	10 / 450	
W 90064	1 Way Switch with Indicator	144.00	163.00	10 / 450	
WOOD-em SLIM POWER SWITCHES					
W 90065	32 Amp. 1 Way DP Switch with Indicator (Heavy Duty Double Pole Main Switch)	265.00	283.00	10 / 450	

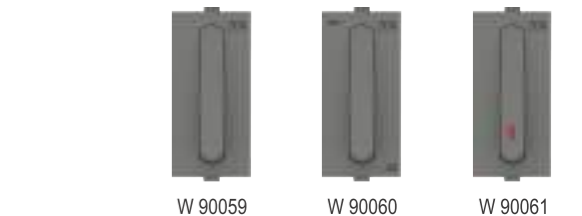



CODE	ITEM	MRP(Rs.)	PURE WHITE	METALLIC CHROME/BLACK	PKG OUTER / MASTER
WOOD-em 10 Amp. ARC SWITCHES NEW					
W 20051	1 Way Switch		58.00	70.00	20 / 1200
W 20052	2 Way Switch		83.00	96.00	20 / 1200
W 20053	1 Way Switch with Indicator		88.00	101.00	20 / 1200
W 20054	Bell Push		88.00	101.00	20 / 1200
W 20055	Bell Push with Indicator		96.00	109.00	20 / 1200

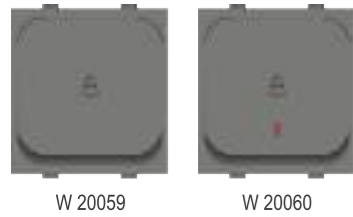
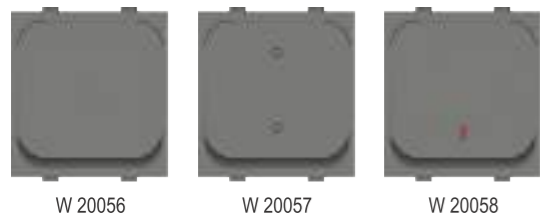

CODE	ITEM	MRP(Rs.)	PURE WHITE	METALLIC CHROME/BLACK	PKG OUTER / MASTER
WOOD-em 10 Amp. ARC GAMA SWITCHES NEW					
W 20056	1 Way Switch		95.00	115.00	10 / 450
W 20057	2 Way Switch		109.00	128.00	10 / 450
W 20058	1 Way Switch with Indicator		109.00	128.00	10 / 450
W 20059	Bell Push		109.00	128.00	10 / 450
W 20060	Bell Push with Indicator		115.00	135.00	10 / 450

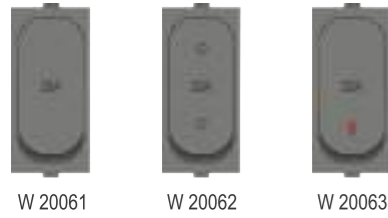

CODE	ITEM	MRP(Rs.)	PURE WHITE	METALLIC CHROME/BLACK	PKG OUTER / MASTER
WOOD-em 20 Amp. ARC SWITCHES NEW					
W 20061	1 Way Switch		99.00	104.00	20 / 1200
W 20062	2 Way Switch		116.00	130.00	20 / 1200
W 20063	1 Way Switch with Indicator		112.00	117.00	20 / 1200

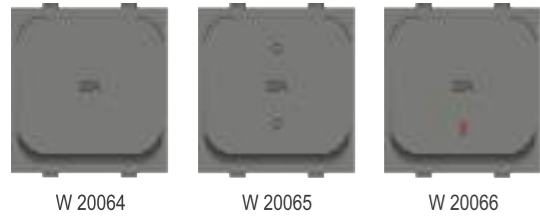

CODE	ITEM	MRP(Rs.)	PURE WHITE	METALLIC CHROME/BLACK	PKG OUTER / MASTER
WOOD-em 20 Amp. ARC GAMA SWITCHES NEW					
W 20064	1 Way Switch		127.00	145.00	10 / 450
W 20065	2 Way Switch		135.00	154.00	10 / 450
W 20066	1 Way Switch with Indicator		135.00	154.00	10 / 450



CODE	ITEM	MRP(Rs.)	PURE WHITE	METALLIC CHROME/BLACK	PKG OUTER / MASTER
WOOD-em ARC POWER SWITCHES NEW					
W 20067	32 Amp. 1 Way DP Switch with Indicator (Heavy Duty Double Pole Main Switch)		254.00	273.00	10 / 450

NEWLY INTRODUCED

CODE	ITEM	MRP(Rs.)	PURE WHITE	METALLIC CHROME/BLACK	PKG OUTER / MASTER
WOOD-em 10 Amp. CHARM SWITCHES NEW					
W 80051	1 Way Switch		58.00	70.00	20 / 1200
W 80052	2 Way Switch		83.00	96.00	20 / 1200
W 80053	1 Way Switch with Indicator		88.00	101.00	20 / 1200
W 80054	Bell Push		88.00	101.00	20 / 1200
W 80055	Bell Push with Indicator		96.00	109.00	20 / 1200

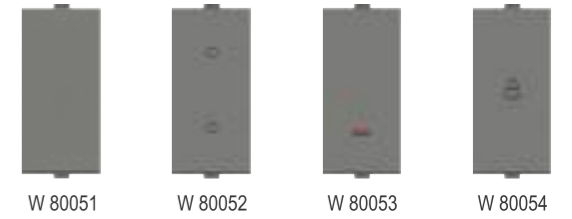

CODE	ITEM	MRP(Rs.)	PURE WHITE	METALLIC CHROME/BLACK	PKG OUTER / MASTER
WOOD-em 10 Amp. CHARM GAMA SWITCHES NEW					
W 80056	1 Way Switch		95.00	115.00	10 / 450
W 80057	2 Way Switch		109.00	128.00	10 / 450
W 80058	1 Way Switch with Indicator		109.00	128.00	10 / 450
W 80059	Bell Push		109.00	128.00	10 / 450
W 80060	Bell Push with Indicator		115.00	135.00	10 / 450

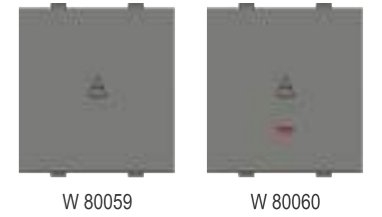

CODE	ITEM	MRP(Rs.)	PURE WHITE	METALLIC CHROME/BLACK	PKG OUTER / MASTER
WOOD-em 20 Amp. CHARM SWITCHES NEW					
W 80061	1 Way Switch		99.00	104.00	20 / 1200
W 80062	2 Way Switch		116.00	130.00	20 / 1200
W 80063	1 Way Switch with Indicator		112.00	117.00	20 / 1200



CODE	ITEM	MRP(Rs.)	PURE WHITE	METALLIC CHROME/BLACK	PKG OUTER / MASTER
WOOD-em 20 Amp. CHARM GAMA SWITCHES NEW					
W 80064	1 Way Switch		127.00	145.00	10 / 450
W 80065	2 Way Switch		135.00	154.00	10 / 450
W 80066	1 Way Switch with Indicator		135.00	154.00	10 / 450



CODE	ITEM	MRP(Rs.)	PURE WHITE	METALLIC CHROME/BLACK	PKG OUTER / MASTER
WOOD-em CHARM POWER SWITCHES NEW					
W 80067	32 Amp. 1 Way DP Switch with Indicator (Heavy Duty Double Pole Main Switch)		254.00	273.00	10 / 450



NEWLY INTRODUCED



NEWLY INTRODUCED

CODE	ITEM	MRP(Rs.)	PURE WHITE	METALLIC CHROME/BLACK	PKG OUTER / MASTER
WOOD-em 10 Amp. PRIME SWITCHES NEW					
W 90031	1 Way Switch		58.00	70.00	20 / 1200
W 90032	2 Way Switch		83.00	96.00	20 / 1200
W 90033	1 Way Switch with Indicator		88.00	101.00	20 / 1200
W 90034	Bell Push		88.00	101.00	20 / 1200
W 90035	Bell Push with Indicator		96.00	109.00	20 / 1200
WOOD-em 10 Amp. PRIME GAMA SWITCHES NEW					
W 90036	1 Way Switch		95.00	115.00	10 / 450
W 90037	2 Way Switch		109.00	128.00	10 / 450
W 90038	1 Way Switch with Indicator		109.00	128.00	10 / 450
W 90039	Bell Push		109.00	128.00	10 / 450
W 90040	Bell Push with Indicator		115.00	135.00	10 / 450
WOOD-em 20 Amp. PRIME SWITCHES NEW					
W 90041	1 Way Switch		99.00	104.00	20 / 1200
W 90042	2 Way Switch		116.00	130.00	20 / 1200
W 90043	1 Way Switch with Indicator		112.00	117.00	20 / 1200
WOOD-em 20 Amp. PRIME GAMA SWITCHES NEW					
W 90044	1 Way Switch		127.00	145.00	10 / 450
W 90045	2 Way Switch		135.00	154.00	10 / 450
W 90046	1 Way Switch with Indicator		135.00	154.00	10 / 450
WOOD-em PRIME POWER SWITCHES NEW					
W 90047	32 Amp. 1 Way DP Switch with Indicator (Heavy Duty Double Pole Main Switch)		254.00	273.00	10 / 450

CODE	ITEM	MRP(Rs.)	PURE WHITE	METALLIC CHROME/BLACK	PKG OUTER / MASTER
WOOD-em 6AMP / 13AMP SOCKETS					
W 10019	6 Amp. 2 Pin Socket with Safety Shutter		75.00	89.00	20 / 1200
W 10020	6 Amp. 2 in 1 Socket		90.00	101.00	10 / 600
W 10062	6Amp. 3 Pin Socket		90.00	101.00	10 / 600
W 10022	13 Amp. International Socket with Safety Shutter		141.00	159.00	10 / 450
WOOD-em 6&16A / 6&25A SOCKETS with SAFETY SHUTTER					
W 10023	6&16A Universal Socket with Safety Shutter		142.00	153.00	10 / 450
W 10024	6&25A Universal Socket with Safety Shutter		178.00	199.00	10 / 450
W 10058	6&16A Raised Socket with Safety Shutter		142.00	153.00	10 / 450
W 10060	6&25A Raised Socket with Safety Shutter		178.00	199.00	10 / 450
W 10068	6&16A Universal Socket (Porcelain)		142.00	153.00	10 / 300
WOOD-em ELECTRONIC DIMMERS / REGULATORS					
W 10026	GLAZE Mini Dimmer		221.00	234.00	10 / 600
W 10027	GLAZE Medium Dimmer		295.00	313.00	10 / 450
W 10028	GLAZE EME 4 Step Fan Regulator		310.00	315.00	10 / 600
W 10029	GLAZE EME 5 Step Fan Regulator		347.00	353.00	10 / 450
W 10053	EME 5 Step WEGA Fan Regulator - Full Rotary		347.00	353.00	10 / 450
W 10054	CRYSTAL Mini Dimmer		221.00	234.00	10 / 600
W 10055	CRYSTAL Medium Dimmer		295.00	313.00	10 / 450
W 10056	CRYSTAL 4 Step Fan Regulator - Full Rotary		310.00	315.00	10 / 600
W 10057	CRYSTAL 5 Step Fan Regulator - Full Rotary		347.00	353.00	10 / 450
W 10072	CRYSTAL 8 Step Fan Regulator - Full Rotary		362.00	382.00	10 / 450

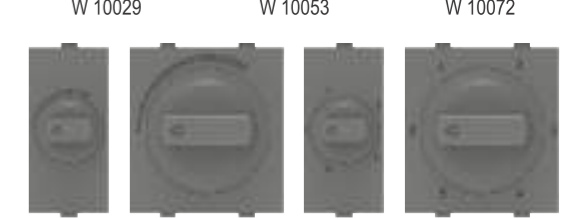
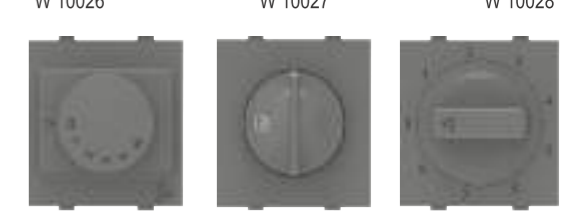
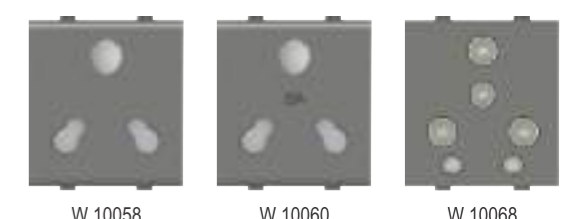
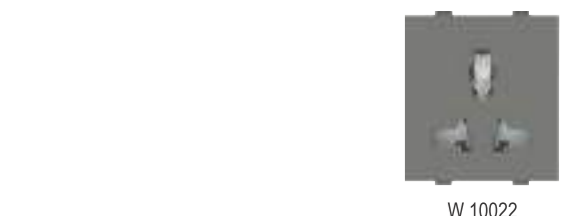
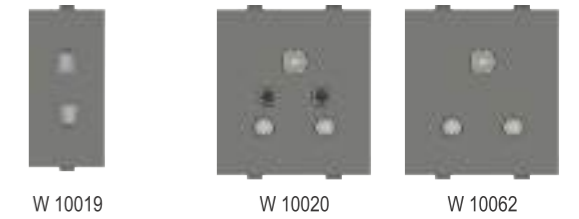

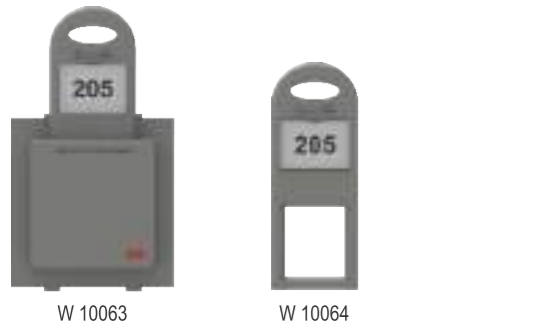
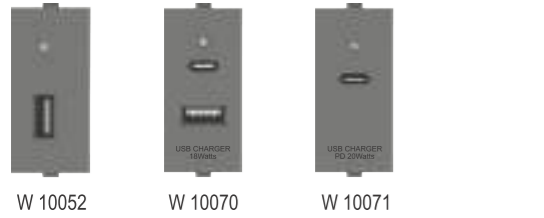
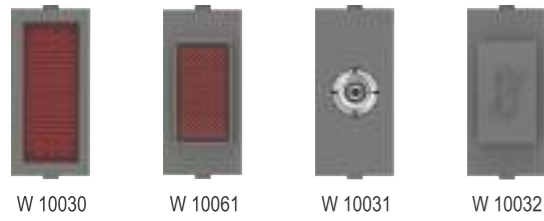

CODE	ITEM	MRP(Rs.)	PURE WHITE	METALLIC CHROME/BLACK	PKG OUTER/MASTER
WOOD-em INDICATOR/TV ANT./KITKAT/USB					
W 10030	Neon Indicator		68.00	82.00	20 / 1200
W 10061	Divine Indicator		68.00	82.00	20 / 1200
W 10031	Mini TV Antenna (with cord-grip configuration)		85.00	97.00	20 / 1200
W 10032	Kitkat Fuse (suitable for 10 Amp. & 16 Amp.)		97.00	110.00	20 / 1200
W 10052	USB Charger (single USB Type-A) (9W)		584.00	596.00	10 / 600
W 10070*	USB Charger with Indicator (New) 2 Port C-Type & A-Type (Fast Charging) Input 240V~ 50-60Hz Output-18W 3.1A		1111.00	1124.00	10 / 600
W 10071*	USB Charger with Indicator (New) 1 Port C-Type (Fast Charging) Input 240V~ 50-60Hz Output-20W 3.1A		908.00	921.00	10 / 600

CODE	ITEM	MRP(Rs.)	PURE WHITE	METALLIC CHROME/BLACK	PKG OUTER/MASTER
WOOD-em TEL. JACK / COMP. JACK / BLANK PLATE					
W 10033	Telephone Jack - Single with Shutter		92.00	105.00	20 / 1200
W 10034	Telephone Jack - Double without Shutter		123.00	137.00	20 / 1200
W 10035	Computer Jack with Shutter		149.00	168.00	10 / 450
W 10037	Blank Plate - Single		19.00	22.00	50 / 3000

CODE	ITEM	MRP(Rs.)	PURE WHITE	METALLIC CHROME/BLACK	PKG OUTER/MASTER
WOOD-em HOTEL & HOSPITALITY RANGE					
W 10063	Nova 32 Amp. D.P. Main Switch with Key Ring Tag		472.00	508.00	10 / 200
W 10064	Nova Key Ring Tag Only		107.00	122.00	200 / 4000

CODE	ITEM	MRP(Rs.)	PURE WHITE	METALLIC CHROME/BLACK	PKG OUTER/MASTER
WOOD-em BUZZER / NIGHT LAMP / MINI LED FOOT LIGHT					
W 10040	Electric Buzzer		263.00	282.00	10 / 450
W 10041	LED Moon Night Lamp □ Cool White		255.00	275.00	10 / 450
W 10042	2M Mini LED Foot Light ■ Red ■ Blue □ Warm White □ Cool White		255.00	275.00	10 / 450
W 10042A	3M LED Foot Light □ Cool White		383.00	409.00	10 / 300

CODE	ITEM	MRP(Rs.)	PURE WHITE	METALLIC CHROME/BLACK	PKG OUTER/MASTER
WOOD-em FOOT LIGHT / LED FOOT LIGHT					
W 10043	UNO 4M Foot Light with 18 LEDs		485.00	510.00	05 / 120
W 10044	SIRIO 4M Foot Light Diffused with 18 LEDs		485.00	510.00	05 / 120
W 10065	PRISCA 4M Foot Light Diffused with 8 LEDs		437.00	462.00	05 / 120
W 10069	LARIO 4M Foot Light Diffused with 8 LEDs		437.00	462.00	05 / 120

CODE	ITEM	MRP(Rs.)	PURE WHITE	METALLIC CHROME/BLACK	PKG OUTER/MASTER
WOOD-em OPEL M.C.B.					
W 10045	OPEL Single Pole M.C.B. (6 Amp. to 32 Amp.)		220.00	232.00	10 / 600
W 10046	OPEL Double Pole M.C.B. (6 Amp. to 32 Amp.)		478.00	502.00	10 / 300

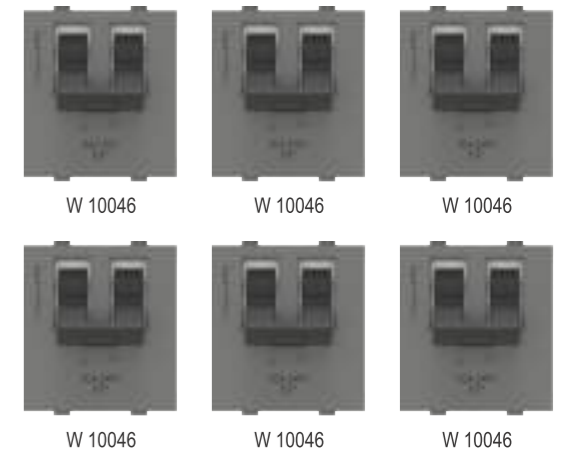
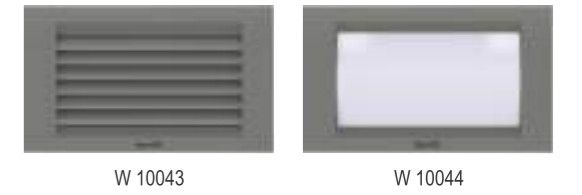

* NEWLY INTRODUCED

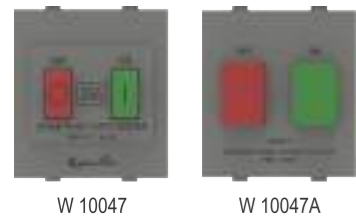
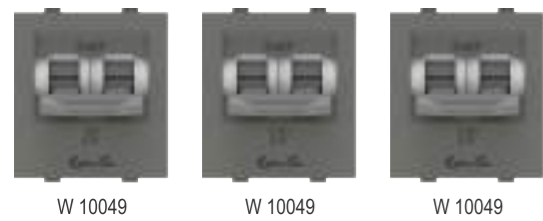

CODE	ITEM	MRP(Rs.)	PURE WHITE	METALLIC CHROME/BLACK	PKG OUTER / MASTER
WOOD-em IKON M.C.B.					
W 10048	IKON Single Pole M.C.B. (6 Amp. to 32 Amp.)		241.00	251.00	10 / 600
W 10049	IKON Double Pole M.C.B. (6 Amp. to 32 Amp.)		486.00	507.00	10 / 300
WOOD-em MOTOR STARTER					
W 10047	25 Amp. Single Phase Motor Starter		463.00	488.00	10 / 300
W 10047A*	25 Amp. Single Phase Motor Starter (New)		463.00	488.00	10 / 300
WOOD-em WAVE PLUS					
W 10101*	Wave Plus Modular Plug, Socket Enclosure & Mini MCB (New) (with Metal box)		986.00	-	01 / 50

* NEWLY INTRODUCED



A-NINE
MODULAR PLATES



ARROW
MODULAR PLATES

AIR
MODULAR PLATE



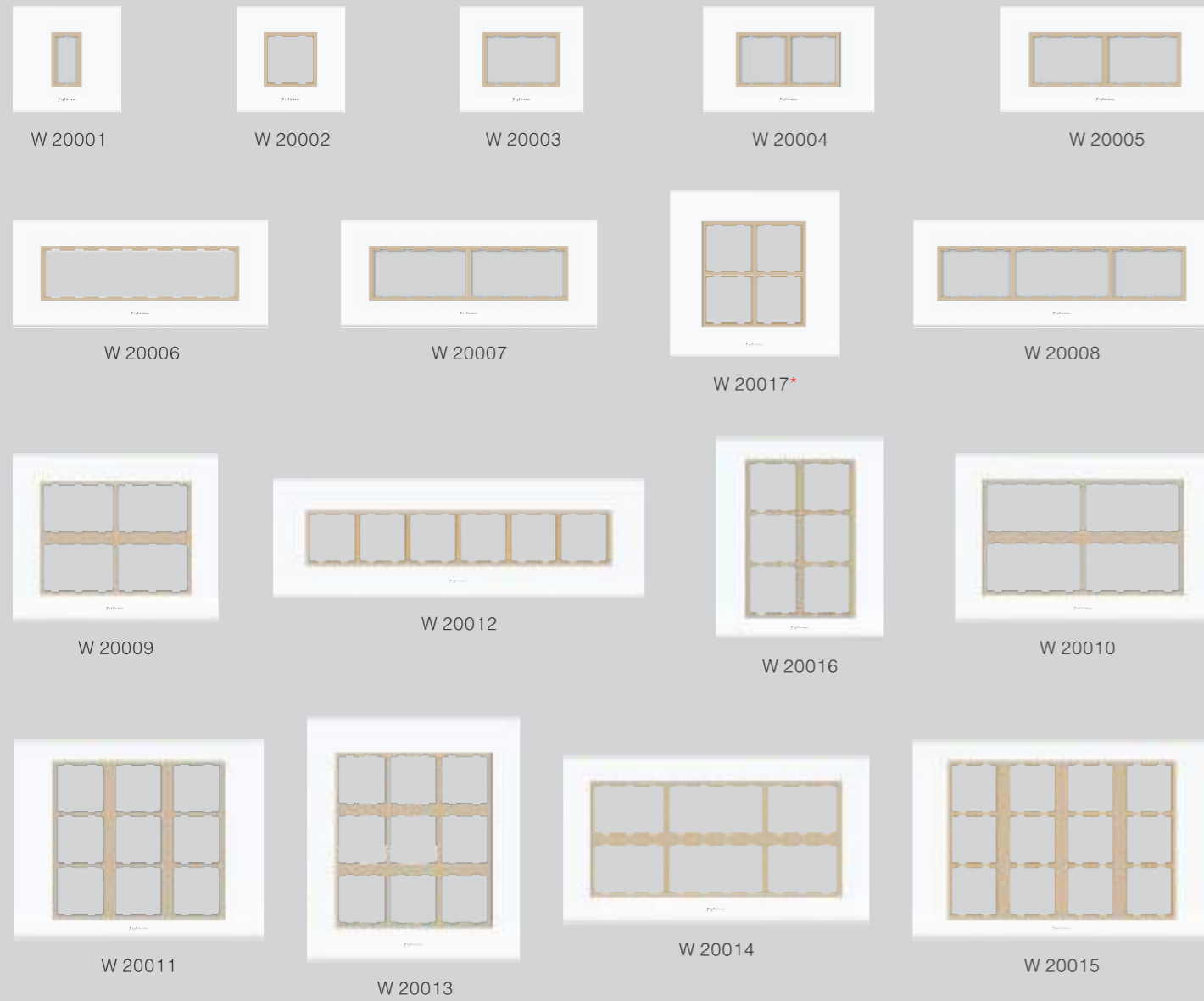

AXCENT WOODEN MODULAR PLATES WITH MOUNTING FRAMES - SUITABLE FOR WOODEN BOX

MODULES	1M	2M	3M	4M	6M	8M-W/P	8M-H	8M-V*	10M	12M-V	12M-H	12M-P	16M	18M-H	18M-V	20M	24M
COLOUR	MRP ₹	MRP ₹	MRP ₹	MRP ₹	MRP ₹	MRP ₹	MRP ₹	MRP ₹	MRP ₹	MRP ₹	MRP ₹	MRP ₹	MRP ₹	MRP ₹	MRP ₹	MRP ₹	MRP ₹
BASIC	₹ 83/-	₹ 83/-	₹ 97/-	₹ 126/-	₹ 147/-	₹ 174/-	₹ 174/-	₹ 174/-	₹ 196/-	₹ 211/-	₹ 303/-	₹ 211/-	₹ 241/-	₹ 276/-	₹ 276/-	₹ 328/-	₹ 381/-
BASIC PREMIUM	₹ 95/-	₹ 95/-	₹ 120/-	₹ 148/-	₹ 177/-	₹ 216/-	₹ 216/-	₹ 216/-	₹ 251/-	₹ 280/-	₹ 380/-	₹ 280/-	₹ 310/-	₹ 365/-	₹ 365/-	₹ 430/-	₹ 477/-
METALLIC PREMIUM	₹ 153/-	₹ 153/-	₹ 195/-	₹ 250/-	₹ 303/-	₹ 389/-	₹ 389/-	₹ 389/-	₹ 443/-	₹ 485/-	₹ 584/-	₹ 485/-	₹ 558/-	₹ 607/-	₹ 607/-	₹ 692/-	₹ 752/-
WOOD	₹ 146/-	₹ 146/-	₹ 177/-	₹ 250/-	₹ 273/-	₹ 359/-	₹ 359/-	₹ 359/-	₹ 389/-	₹ 412/-	₹ 573/-	₹ 412/-	₹ 473/-	₹ 571/-	₹ 571/-	₹ 666/-	₹ 733/-
CODE	W 20001	W 20002	W 20003	W 20004	W 20005	W 20006	W 20007	W 20017	W 20008	W 20009	W 20012	W 20016	W 20010	W 20011	W 20013	W 20014	W 20015
PKG.	10/480	10/480	10/360	10/240	10/240	10/240	10/240	10/240	10/200	10/180	10/100	10/180	10/180	10/100	10/100	10/120	10/100
SIZE (inches)	4.5 X 4.5	4.5 X 4.5	4.5 X 5	4.5 X 7	4.5 X 8.5	4.5 X 10.5	4.5 X 10.5	7.0 X 7.0	4.5 X 12.5	7.0 X 8.5	5.0 X 15.5	8.5 X 7	7.0 X 10.5	8.5 X 10.5	10.5 X 9	7.0 X 12.5	8.5 X 12.5

* NEWLY INTRODUCED

A-NINE WOODEN MODULAR PLATES WITH MOUNTING FRAMES - SUITABLE FOR WOODEN BOX

MODULES	1M	2M	3M	4M	6M	8M-W/P	8M-H	8M-V	10M	12M-V	12M-P	12M-H	16M	18M-H	18M-V	20M	24M
Colour	MRP ₹	MRP ₹	MRP ₹	MRP ₹	MRP ₹	MRP ₹	MRP ₹	MRP ₹	MRP ₹	MRP ₹	MRP ₹	MRP ₹	MRP ₹	MRP ₹	MRP ₹	MRP ₹	MRP ₹
BASIC	₹ 83/-	₹ 83/-	₹ 97/-	₹ 126/-	₹ 147/-	₹ 174/-	₹ 174/-	₹ 174/-	₹ 196/-	₹ 211/-	₹ 211/-	₹ 303/-	₹ 241/-	₹ 276/-	₹ 276/-	₹ 328/-	₹ 381/-
BASIC PREMIUM	₹ 95/-	₹ 95/-	₹ 120/-	₹ 148/-	₹ 177/-	₹ 216/-	₹ 216/-	₹ 216/-	₹ 251/-	₹ 280/-	₹ 280/-	₹ 380/-	₹ 310/-	₹ 365/-	₹ 365/-	₹ 430/-	₹ 477/-
METALLIC	₹ 128/-	₹ 128/-	₹ 149/-	₹ 197/-	₹ 230/-	₹ 272/-	₹ 272/-	₹ 272/-	₹ 311/-	₹ 334/-	₹ 334/-	₹ 478/-	₹ 377/-	₹ 432/-	₹ 432/-	₹ 518/-	₹ 601/-
CODE	W 60001	W 60002	W 60003	W 60004	W 60005	W 60006	W 60007	W 60016	W 60008	W 60009	W 60017	W 60012	W 60010	W 60011	W 60013	W 60014	W 60015
PKG.	10/480	10/480	10/360	10/240	10/240	10/240	10/240	10/240	10/200	10/180	10/180	10/100	10/180	10/100	10/100	10/120	10/100
SIZE (inches)	4.5 X 4.5	4.5 X 4.5	4.5 X 5	4.5 X 7	4.5 X 8.5	4.5 X 10.5	4.5 X 10.5	7.0 X 7.0	4.5 X 12.5	7.0 X 8.5	9.0 X 7.0	4.5 X 15.5	7.0 X 10.5	8.5 X 10.5	10.5 X 8.5	7.0 X 12.5	8.5 X 12.5



ARROW MODULAR PLATES WITH MOUNTING FRAMES - SUITABLE FOR METAL BOX

MODULES >	1M	2M	3M	4M	6M	8M - H	8M - V	12M	16M	18M
PLATES >	MRP ₹	MRP ₹	MRP ₹	MRP ₹	MRP ₹	MRP ₹	MRP ₹	MRP ₹	MRP ₹	MRP ₹
BASIC	₹ 68/-	₹ 68/-	₹ 83/-	₹ 99/-	₹ 142/-	₹ 178/-	₹ 178/-	₹ 224/-	₹ 237/-	₹ 265/-
BASIC PREMIUM	₹ 79/-	₹ 79/-	₹ 95/-	₹ 107/-	₹ 158/-	₹ 193/-	₹ 193/-	₹ 260/-	₹ 294/-	₹ 298/-
METALLIC	₹ 124/-	₹ 124/-	₹ 163/-	₹ 179/-	₹ 246/-	₹ 331/-	₹ 331/-	₹ 410/-	₹ 468/-	₹ 479/-
WOOD	₹ 135/-	₹ 135/-	₹ 179/-	₹ 207/-	₹ 268/-	₹ 366/-	₹ 366/-	₹ 501/-	₹ 534/-	₹ 558/-
CODE >	W 70001	W 70002	W 70003	W 70004	W 70005	W 70006	W 70007	W 70008	W 70010	W 70009
PKG. >	10/600	10/600	10/600	10/450	10/300	10/300	10/270	10/240	10/200	10/160
SIZE (mm) >	90 X 94	90 X 94	90 X 118	90 X 146	90 X 220	90 X 260	158 X 152	158 X 220	158 X 260	220 X 220

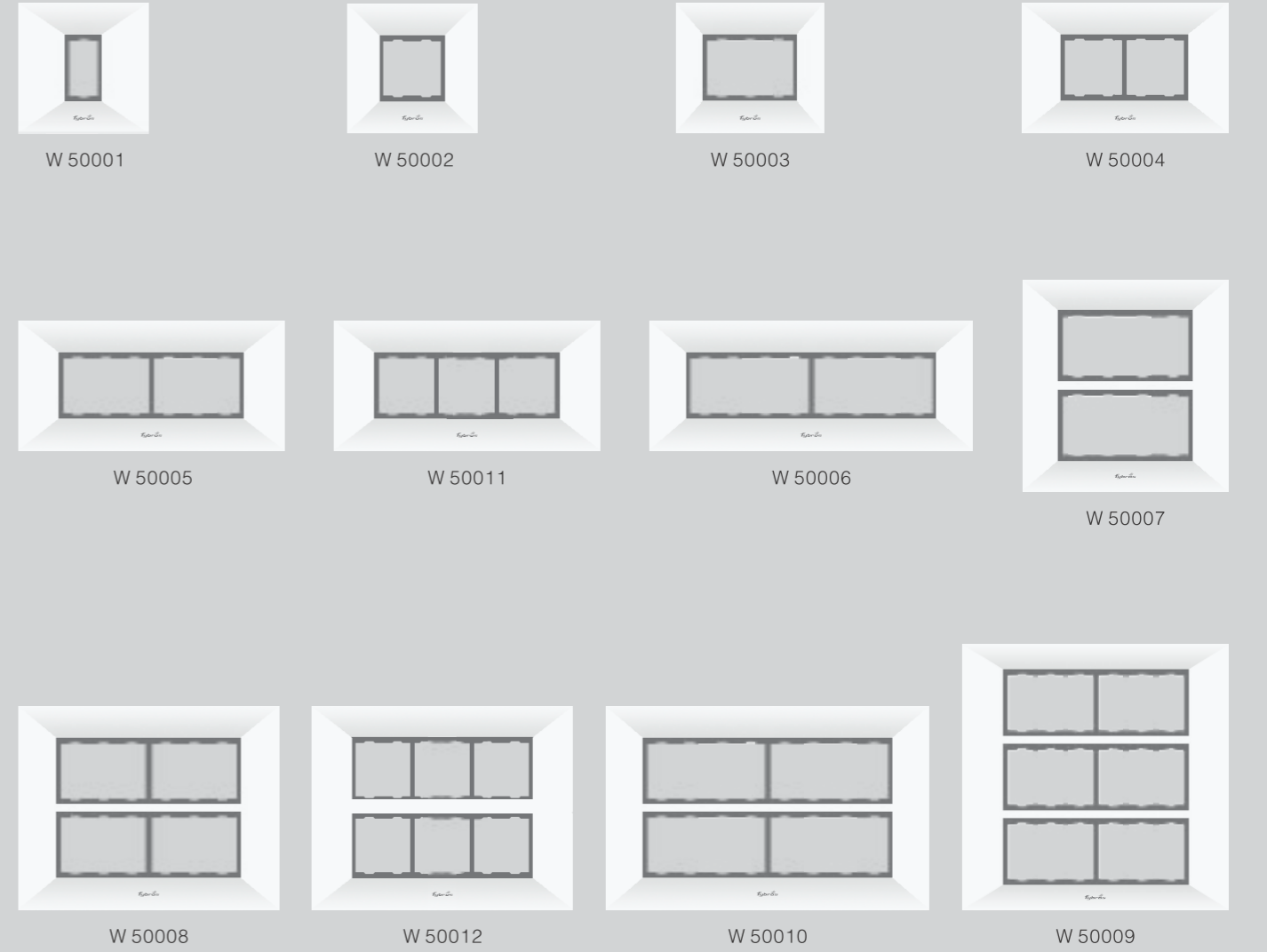

AIR MODULAR PLATES WITH MOUNTING FRAMES - SUITABLE FOR METAL BOX

MODULES >	1M	2M	3M	4M	6M	6M-P	8M - H	8M - V	12M	12M-P	16M	18M
PLATES >	MRP ₹	MRP ₹	MRP ₹	MRP ₹	MRP ₹	MRP ₹	MRP ₹	MRP ₹	MRP ₹	MRP ₹	MRP ₹	MRP ₹
BASIC	₹ 68/-	₹ 68/-	₹ 83/-	₹ 99/-	₹ 142/-	₹ 142/-	₹ 178/-	₹ 178/-	₹ 224/-	₹ 224/-	₹ 237/-	₹ 265/-
METALLIC	₹ 124/-	₹ 124/-	₹ 163/-	₹ 179/-	₹ 246/-	₹ 246/-	₹ 331/-	₹ 331/-	₹ 410/-	₹ 410/-	₹ 468/-	₹ 479/-
WOOD	₹ 135/-	₹ 135/-	₹ 179/-	₹ 207/-	₹ 268/-	₹ 268/-	₹ 366/-	₹ 366/-	₹ 501/-	₹ 501/-	₹ 534/-	₹ 558/-
CODE >	W 50001	W 50002	W 50003	W 50004	W 50005	W 50011	W 50006	W 50007	W 50008	W 50012	W 50010	W 50009
PKG. >	10/600	10/600	10/600	10/450	10/300	10/300	10/300	10/270	10/240	10/240	10/200	10/160
SIZE (mm) >	90 X 94	90 X 94	90 X 118	90 X 146	90 X 220	90 X 220	93 X 260	158 X 152	158 X 220	158 X 220	158 X 260	220 X 220



W 30051



W 30052



W 30053



W 30054



W 30055



W 30056



W 30057

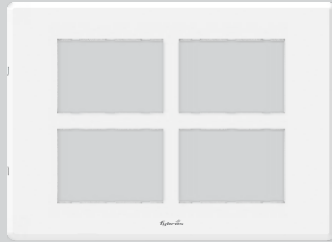

W 30058

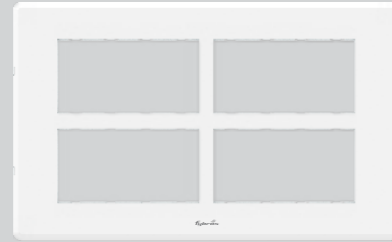

W 30060

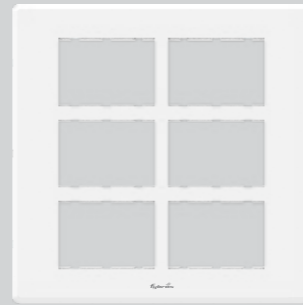

W 30059

ASTRA MODULAR PLATES WITH MOUNTING FRAMES - SUITABLE FOR METAL BOX

MODULES	1M	2M	3M	4M	6M	8M - H	8M - V	12M	16M	18M
PLATES	MRP ₹	MRP ₹	MRP ₹	MRP ₹	MRP ₹	MRP ₹	MRP ₹	MRP ₹	MRP ₹	MRP ₹
BASIC	₹ 68/-	₹ 68/-	₹ 83/-	₹ 99/-	₹ 142/-	₹ 178/-	₹ 178/-	₹ 224/-	₹ 237/-	₹ 265/-
CODE	W 30051	W 30052	W 30053	W 30054	W 30055	W 30056	W 30057	W 30058	W 30060	W 30059
PKG.	10/600	10/600	10/600	10/450	10/300	10/300	10/270	10/240	10/200	10/160
SIZE (mm)	95 X 98	95 X 98	95 X 123	95 X 150	95 X 225	95 X 265	163 X 156	163 X 225	163 X 265	225 X 225

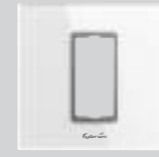

W 70051

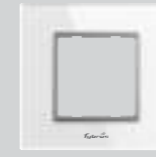

W 70052

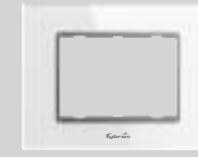

W 70053



W 70054

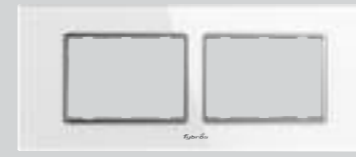

W 70055

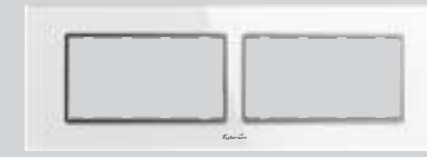

W 70056

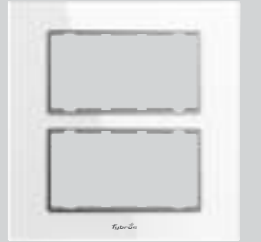

W 70057

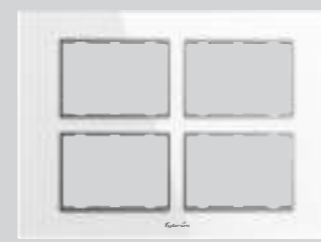

W 70058

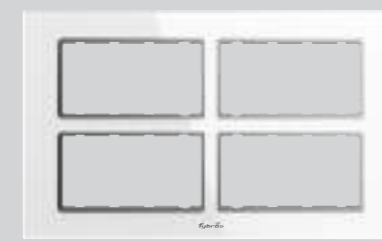

W 70059



W 70060

ALPHA ACRYLIC MODULAR PLATES WITH MOUNTING FRAMES - SUITABLE FOR METAL BOX

MODULES	1M	2M	3M	4M	6M	8M - H	8M - V	12M	16M	18M
PLATES	MRP ₹	MRP ₹	MRP ₹	MRP ₹	MRP ₹	MRP ₹	MRP ₹	MRP ₹	MRP ₹	MRP ₹
ACRYLIC	₹ 246/-	₹ 246/-	₹ 314/-	₹ 361/-	₹ 477/-	₹ 571/-	₹ 571/-	₹ 711/-	₹ 804/-	₹ 897/-
CODE	W 70051	W 70052	W 70053	W 70054	W 70055	W 70056	W 70057	W 70058	W 70059	W 70060
PKG.	10/180	10/180	10/180	10/180	05/90	05/90	05/90	05/60	05/40	05/40
SIZE (mm)	90 X 94	90 X 94	90 X 118	90 X 146	90 X 220	90 X 260	158 X 152	158 X 220	158 X 260	220 X 220

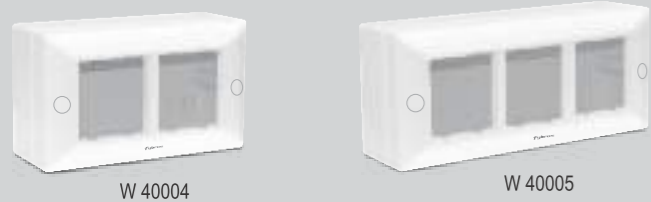

CODE	ITEM	MRP(Rs.)	PKG OUTER / MASTER
WOOD-em SWING MODULAR SURFACE GANG BOX			
W 40001	1M. Swing Surface Gang Box	74.00	20 / 360
W 40002	2M. Swing Surface Gang Box	86.00	10 / 180
W 40003	3M. Swing Surface Gang Box	98.00	10 / 180
W 40004	4M. Swing Surface Gang Box	118.00	10 / 180
W 40005	6M. Swing Surface Gang Box	138.00	10 / 120
W 40006	8M - H Swing Surface Gang Box	167.00	10 / 120
W 40007	8M - V Swing Surface Gang Box	167.00	05 / 90
W 40011	9M. Swing Surface Gang Box	189.00	10 / 120
W 40008	12M. Swing Surface Gang Box	221.00	05 / 90
W 40009	16M. Swing Surface Gang Box	287.00	05 / 60
W 40010	18M. Swing Surface Gang Box	291.00	05 / 60

WOOD-em SWING MODULAR SURFACE GANG BOX

CODE	ITEM	MRP(Rs.)	PKG OUTER / MASTER
WOOD-em OVAL MODULAR SURFACE GANG BOX			
W 40051	1M. Oval Surface Gang Box	74.00	20 / 360
W 40052	2M. Oval Surface Gang Box	86.00	10 / 180
W 40053	3M. Oval Surface Gang Box	98.00	10 / 180
W 40054	4M. Oval Surface Gang Box	118.00	10 / 180
W 40055	6M. Oval Surface Gang Box	138.00	10 / 120
W 40056	8M - H Oval Surface Gang Box	167.00	10 / 120
W 40057	8M - V Oval Surface Gang Box	167.00	05 / 90
W 40061	9M. Oval Surface Gang Box	189.00	10 / 120
W 40058	12M. Oval Surface Gang Box	221.00	05 / 90
W 40059	16M. Oval Surface Gang Box	287.00	05 / 60
W 40060	18M. Oval Surface Gang Box	291.00	05 / 60

WOOD-em OVAL MODULAR SURFACE GANG BOX



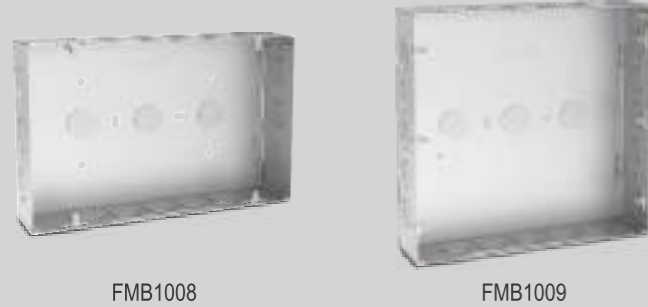
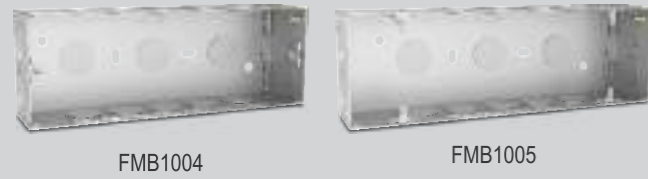

CODE	ITEM	MRP(Rs.)	PKG OUTER / MASTER
WOOD-em REMOVE METAL GANG BOX			
FMB1001	1 & 2M. Remove Metal Gang Box	76.00	20 / 120
FMB1002	3M. Remove Metal Gang Box	93.00	20 / 120
FMB1003	4M. Remove Metal Gang Box	105.00	20 / 120
FMB1004	6M. Remove Metal Gang Box	160.00	10 / 80
FMB1005	8M - H Remove Metal Gang Box	197.00	10 / 80
FMB1006	8M - V Remove Metal Gang Box	197.00	05 / 60
FMB1007	12M. Remove Metal Gang Box	249.00	05 / 40
FMB1008	16M. Remove Metal Gang Box	306.00	05 / 40
FMB1009	18M. Remove Metal Gang Box	348.00	05 / 40

BASIC

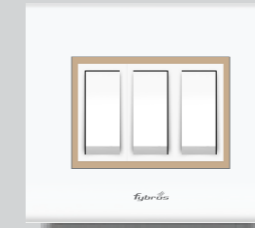

Basic Ivory

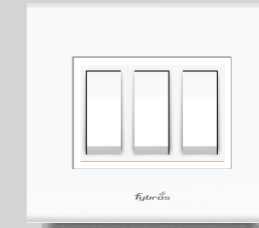

Basic White



Basic Premium

METALLIC
premium

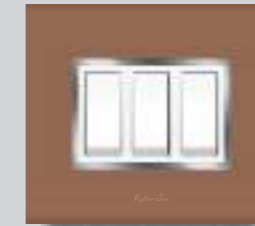

Chocolate Brown



Metallic Chrome Premium

WOOD



African Wenge



Italian Walnut



Cherry Wood

A-NINE
MODULAR PLATES

BASIC



Basic Ivory

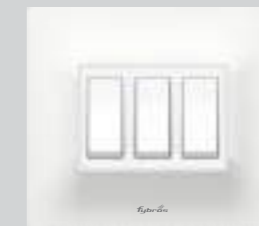

Basic White

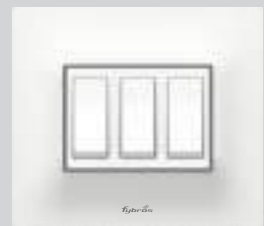

Basic Green

BASIC
premium

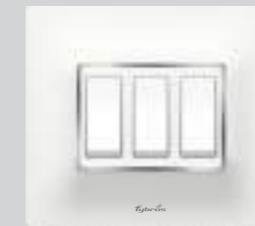

Basic Premium

METALLIC

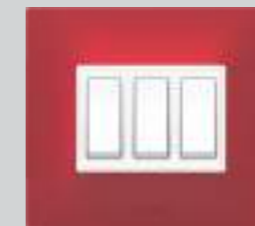

Cherry Red* (NEW)

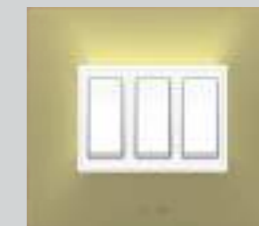

Aqua Green* (NEW)



Aqua Blue* (NEW)

BASIC



Basic Green

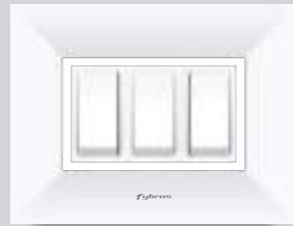

Basic White



Basic Grey

METALLIC

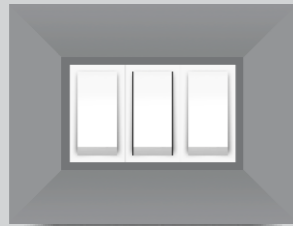

Platinum Chrome

WOOD



African Wenge



Italian Walnut

ALPHA NEW
ACRYLIC PLATES

BASIC

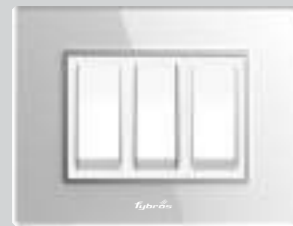

Polar White* (NEW)



Thunder Chrome* (NEW)

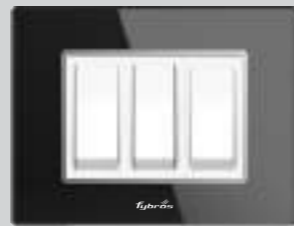

Space Black* (NEW)

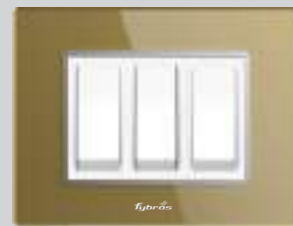

Warm Tan* (NEW)

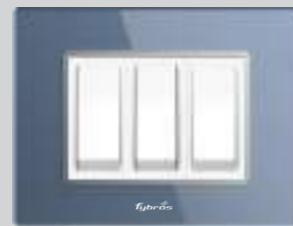

Galaxy Blue* (NEW)



Deep Maroon* (NEW)

BASIC

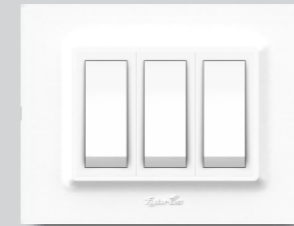

Basic White

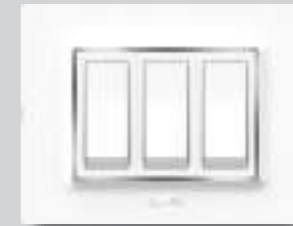

Basic Premium

BASIC
premium

METALLIC



Mystic Copper

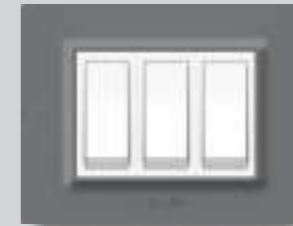

Mystic Chrome

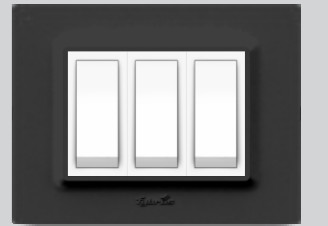

Matty Black



Cherry Red* (NEW)



Aqua Green* (NEW)



Aqua Blue* (NEW)



Majestic Yellow* (NEW)

WOOD



Italian Walnut

ASTRA
MODULAR PLATES

BASIC

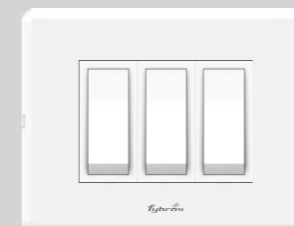

Basic White

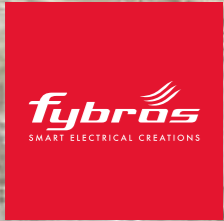

ZINE
SERIES

GLOW



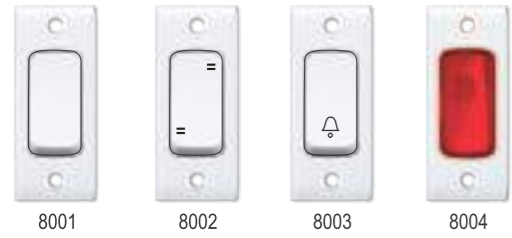

CODE	ITEM	MRP(Rs.)	PKG OUTER / MASTER
ZINE 6 AMP. GLOW SWITCHES / INDICATOR			
8001	1 Way Switch	30.00	20 / 1200
8002	2 Way Switch	37.00	20 / 1200
8003	Bell Push	37.00	20 / 1200
8004	Indicator	37.00	20 / 1200

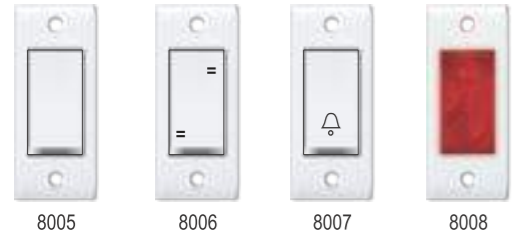

CODE	ITEM	MRP(Rs.)	PKG OUTER / MASTER
ZINE 6 AMP. BLOOM SWITCHES / INDICATOR			
8005	1 Way Switch	30.00	20 / 1200
8006	2 Way Switch	36.00	20 / 1200
8007	Bell Push	36.00	20 / 1200
8008	Indicator	36.00	20 / 1200

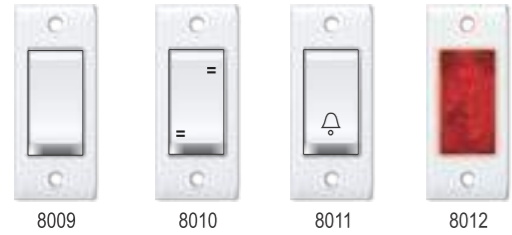

CODE	ITEM	MRP(Rs.)	PKG OUTER / MASTER
ZINE 6 AMP. SHINE SWITCHES / INDICATOR			
8009	1 Way Switch	30.00	20 / 1200
8010	2 Way Switch	36.00	20 / 1200
8011	Bell Push	36.00	20 / 1200
8012	Indicator	36.00	20 / 1200



CODE	ITEM	MRP(Rs.)	PKG OUTER / MASTER
ZINE 6 AMP. SOCKETS / INTERNATIONAL SOCKET			
8021	2 Pin Socket	36.00	20 / 1200
8022	2 In 1 Socket	43.00	10 / 600
8024	13 Amp. international Socket	86.00	10 / 300
8025	6 Amp. 3 Pin Socket	43.00	10 / 600



CODE	ITEM	MRP(Rs.)	PKG OUTER / MASTER
ZINE TV ANTENA / TEL. JACK / KIT-KAT FUSE / USB			
8031	Mini TV Socket	50.00	20 / 1200
8032	Mini 2 Line Tel. Jack with enclosure	83.00	20 / 1200
8033	10A Kit-Kat Fuse	51.00	20 / 600
8034	16A Kit-Kat Fuse	65.00	10 / 300
8035	USB Charger indicator (with single USB Port) 2Amp. 240~A.C. Only	560.00	10 / 450

CODE	ITEM	MRP(Rs.)	PKG OUTER / MASTER
ZINE DIMMER / REGULATOR			
8041	Mini Dimmer	212.00	10 / 450
8042	Medium Dimmer	219.00	10 / 300
8043	4 Step Regulator	291.00	10 / 450
8044	5 Step Regulator	334.00	10 / 300



CODE	ITEM	MRP(Rs.)	PKG OUTER / MASTER
ZINE 6A S.S. COMBINED WITH JUNCTION BOX			
8051A	6A 3 Pin S.S. Combined indicator	97.00	05 / 200
8052A	6A 3 Pin S.S. Combined indicator & J. Box	110.00	05 / 200



CODE	ITEM	MRP(Rs.)	PKG OUTER / MASTER
ZINE 16AMP. SWITCH & SOCKET			
8053	16A 1 Way Switch	120.00	10 / 200
8053A	16A 1 Way Switch (Dolly)	120.00	10 / 200
8054	16A 2 Way Switch	147.00	10 / 200
8054A	16A 2 Way Switch (Dolly)	147.00	10 / 200
8055	6 & 16A Universal Socket safety shutter	120.00	10 / 200
8055A	6 & 16A Universal Socket	120.00	10 / 200

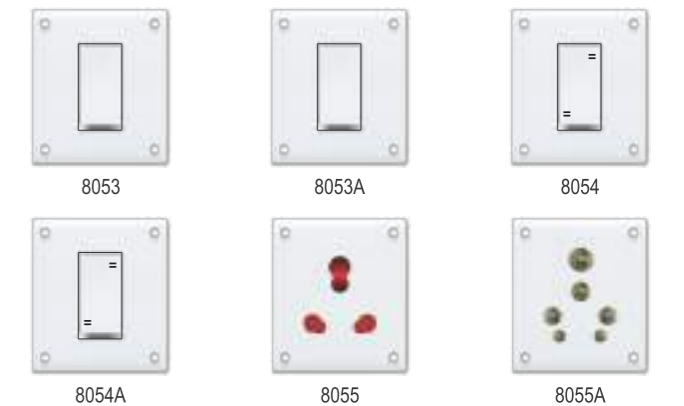

CODE	ITEM	MRP(Rs.)	PKG OUTER / MASTER
ZINE 16AMP. 3 IN ONE WITH JUNCTION BOX			
8056	3 In 1 Uni. S.S. Comb. safety shutter	206.00	05 / 100
8056A	3 In 1 Uni. S.S. Comb. (Dolly)	206.00	05 / 100
8057	3 In 1 Uni. S.S. Combined J. Box safety shutter	224.00	05 / 100
8057A	3 In 1 Uni. S.S. Combined J. Box (Dolly)	224.00	05 / 100

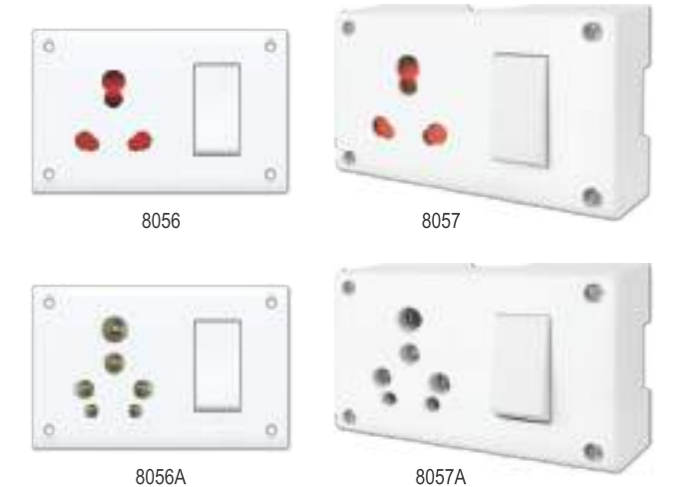



8058



8059



8058A



8059A



8060



8061

CODE	ITEM	MRP(Rs.)	PKG OUTER / MASTER
ZINE 16AMP. 5 IN ONE WITH JUNCTION BOX			
8058	5 In 1 Uni. S.S. Combined fuse, indicator & safety shutter	282.00	05 / 80
8058A	5 In 1 Uni. S.S. Combined (Dolly) fuse, indicator	282.00	05 / 80
8059	5 In 1 Uni. S.S. Combined J. Box fuse, indicator & safety shutter	320.00	05 / 80
8059A	5 In 1 Uni. S.S. Combined J. Box (Dolly) fuse, indicator	320.00	05 / 80

ZINE 32A DP SWITCH (UNBREAKABLE)			
8060	Surface DP Switch with indicator	224.00	05 / 100
8061	Flush DP Switch with indicator	224.00	05 / 100

ZINE PLUS SERIES





CODE	ITEM	MRP(Rs.)	PKG OUTER / MASTER
ZINE SKIRT LAMP HOLDER			
8062	Angle Holder	33.00	20 / 400
8063	Batten Holder	33.00	20 / 400
8064	Pendent Holder	33.00	30 / 600
8066	Adaptor	32.00	30 / 1200
8067	Bed Switch	41.00	20 / 1200



CODE	ITEM	MRP(Rs.)	PKG OUTER / MASTER
ZINE ENCLOSURE BOX (UNBREAKABLE)			
8069	1-2 MCB Enclosure (Plastic)	73.00	10 / 200
8070	3-4 MCB Enclosure (Plastic)	104.00	05 / 100



CODE	ITEM	MRP(Rs.)	PKG OUTER / MASTER
ZINE CEILING ROSE			
8071	Pilot Ceiling Rose	35.00	30 / 600
8072	Pilot Ceiling Rose (3 parts)	36.00	30 / 600
8073	Jumbo Ceiling Rose	37.00	20 / 400
8074	Jumbo Ceiling Rose (3 parts)	43.00	20 / 400



CODE	ITEM	MRP(Rs.)	PKG OUTER / MASTER
ZINE PLUG TOP			
8084	2 Pin Plug	28.00	50 / 1000
8085	2 Pin Male - Female	42.00	50 / 1200
8089	2 Pin Plug / Adora	28.00	50 / 1000
8090	2 Pin Male - Female / Adora	42.00	50 / 1200
8111	2 Pin Plug / Melon	24.00	50 / 1000
8112	2 Pin Male - Female / Melon	40.00	50 / 1000
8113	2 Pin Female / Melon	24.00	100 / 1200



CODE	ITEM	MRP(Rs.)	PKG OUTER / MASTER
ZINE PLUG TOP			
8081	Elace 6A 3 Pin Top (Unbreakable)	72.00	20 / 600
8082	Elace 16A 3 Pin Top (Unbreakable)	98.00	10 / 240
V 3011	Elegant 6A 3 Pin Top (Unbreakable)	77.00	20 / 600
V 3012	Elegant 16A 3 Pin Top (Unbreakable)	98.00	10 / 240
8114	Krysta 6A 3 Pin Top (Unbreakable) with indicator	93.00	20 / 600
8115	Krysta 16A 3 Pin Top (Unbreakable) with indicator	115.00	10 / 240
8088	25A 3 Pin Top (Unbreakable) with indicator	127.00	10 / 240
8118	NEO 6A 3 Pin Top (Urea)	80.00	20 / 600
8119	NEO 16A 3 Pin Top (Urea)	112.00	10 / 240
8087	Rotor Holder (Pair)	29.00	24 / 720



CODE	ITEM	MRP(Rs.)	PKG OUTER / MASTER
ZINE TRAVEL ADAPTOR			
V 3021	Oreo 3 Pin Travel Universal Multi Plug with surge protector & indicator	174.00	10 / 300
8099	Eco 3 Pin Travel Universal Multi Plug with indicator	143.00	10 / 300
8080	Maxx 3 Pin Travel Universal Adaptor	120.00	20 / 600
8117	Xylo 16A 3 Pin Multi Plug Adaptor	220.00	10 / 200
8097	Sliq 3 Pin Travel Universal Multi Plug with indicator	158.00	10 / 300
8086A	3 Pin Multi Plug Adaptor	83.00	20 / 600
8083	3 Pin Travel Universal Adaptor	110.00	20 / 600
8098	Atlas 3 Pin Universal Travel Adaptor with USB	589.00	10 / 200





* NEWLY INTRODUCED

CODE	ITEM	MRP(Rs.)	PKG OUTER / MASTER
ZINE DING DONG BELLS			
9001	Spark Ding Dong Bell stereophonic ding dong	217.00	05 / 100
9002	Aqua Ding Dong Bell stereophonic ding dong	217.00	05 / 100
V 3031	Pulse Ding Dong Bell stereophonic ding dong	217.00	05 / 100
V 3032	Plug Ding Dong Bell stereophonic ding dong	217.00	05 / 100
9003	Wave Ding Dong Bell stereophonic ding dong	274.00	05 / 100
9004	Oval Ding Dong Bell stereophonic ding dong	217.00	05 / 100
9005	Bella Ding Dong Bell stereophonic ding dong	217.00	05 / 100
9006	Fiona Ding Dong Bell stereophonic ding dong	251.00	05 / 100
9007	Elvis Ding Dong Bell stereophonic ding dong	251.00	05 / 100
9008*	Hexa Ding Dong Bell (New) stereophonic ding dong	217.00	05 / 100
9009*	Etos Ding Dong Bell (New) stereophonic ding dong	251.00	05 / 100
9010*	Pearl Ding Dong Bell (New) stereophonic ding dong	217.00	05 / 100

CODE	ITEM	MRP(Rs.)	PKG OUTER / MASTER
ZINE MUSICAL DOOR BELL			
9011	Apple Musical Bell 16 Melodies tune	446.00	05 / 100
9014	Parrot Musical Bell	281.00	05 / 100
9015	Ringo Musical Bell 12 melodies tune	457.00	05 / 80
9016	Itune Musical Bell 12 melodies tune	413.00	10 / 240
V 3041	Musical Bell (Om Mantras) with flashing light	518.00	05 / 100
V 3041A*	Musical Bell (Azaan) (New) with flashing light	518.00	05 / 100
V 3041B*	Musical Bell (Satnam Waheguru) (New) with flashing light	518.00	05 / 100
V 3041C*	Musical Bell (Church) (New) with flashing light	518.00	05 / 100
V 3042	Flora Musical Bell with 16 melodies & flashing light	538.00	05 / 80

CODE	ITEM	MRP(Rs.)	PKG OUTER / MASTER
ZINE SHINE NIGHT LAMP NEW			
8131	SHRI PARASWANATH	231.00	10 / 200
8132	LORD GANESHA	231.00	10 / 200
8133	MAHALAKSHMI	231.00	10 / 200
8134	TIRUPATI BALAJI	231.00	10 / 200
8135	SHRI KRISHNA	231.00	10 / 200
8136	SHIVJI	231.00	10 / 200
8137	AMBE MATA	231.00	10 / 200
8138	SHRI HANUMAN	231.00	10 / 200
8139	GURU NANAK	231.00	10 / 200
8140	AZAAN	231.00	10 / 200
8141	JESUS CHRIST	231.00	10 / 200
8142	SAI BABA	231.00	10 / 200

CODE	ITEM	MRP(Rs.)	PKG OUTER / MASTER
ZINE GLOW NIGHT LAMP NEW			
8146	GLOW Night Lamp (Lord Ganesha Mantra)	231.00	10 / 200

CODE	ITEM	MRP(Rs.)	PKG OUTER / MASTER
ZINE 6AMP / 16AMP FLEX BOX			
8091	Comex 2 Pin Flex Box (5 Mtrs.) with indicator & international socket Red Blue Orange Yellow	357.00	05 / 60
8092	Comex 2 Pin Flex Box (10 Mtrs.) with indicator & international socket Red Blue Orange Yellow	464.00	05 / 60
8093	Comex 3 Pin Flex Box (5 Mtrs.) with indicator & international socket Red Blue Orange Yellow	464.00	05 / 60
8094	Crystal 2 Pin Flex Box (5 Mtrs.) with indicator & international socket	412.00	05 / 60
8095*	Prizma 16A 3 Pin Flex Box (3.5 Mtrs.) with indicator & international socket (New)	1497.00	01 / 60
V 3061	Fusion 2 Pin Flex Box (5 Mtrs.) with indicator & international socket	383.00	05 / 60



* NEWLY INTRODUCED

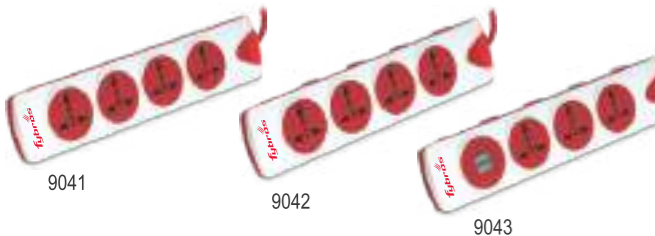
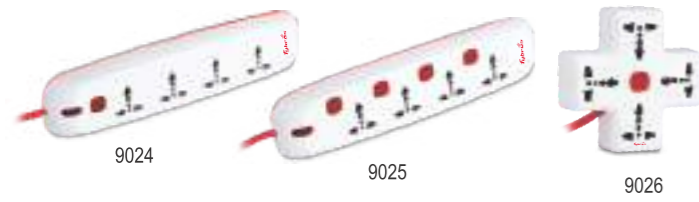
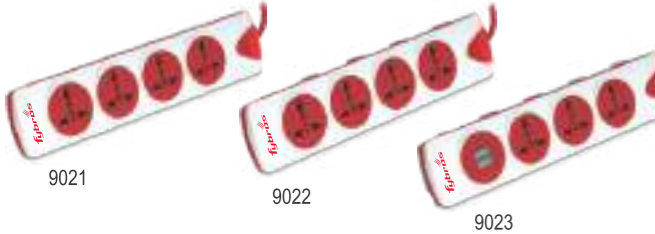
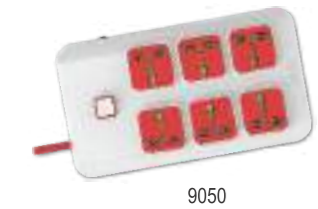
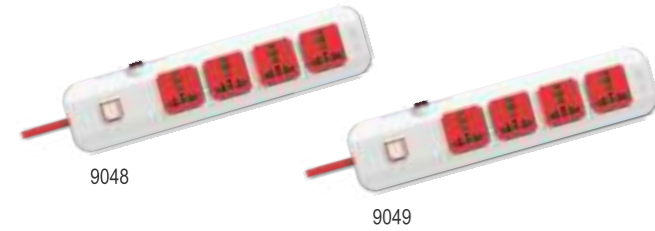

CODE	ITEM	MRP(Rs.)	PKG OUTER / MASTER
------	------	----------	--------------------

ZINE EXTENSION CORDS

9046	Stella 2 Pin Extension Cords with indicator & international socket (2.5 Mtrs.)	440.00	05 / 100
9047	Stella 3 Pin Extension Cords with indicator & international socket (1.5 Mtrs.)	474.00	05 / 100

ZINE SPIKE GUARDS

9048	Curve 4 x 1 Spike Guard master switch, indicator, surge protector & international socket (2 Mtrs.)	1025.00	05 / 50
9049	Curve 4 x 1 Spike Guard master switch, indicator, surge protector & international socket (5 Mtrs.)	1246.00	05 / 50
9050	Curve 6 x 1 Spike Guard master switch, indicator, surge protector & international socket (2 Mtrs.)	1246.00	05 / 40

ZINE POWER STRIP (2Mtrs.)

9021	Qubic 4 x 1 Power Strip master switch, indicator & intl. socket	702.00	05 / 50
9022	Qubic 4 x 4 Power Strip individual switch, indicator & intl. socket	793.00	05 / 50
9023	Qubic 4 x 4 Power Strip with USB individual switch, usb port, indicator & intl. socket	1254.00	05 / 50
9024	Titan 4 x 1 Power Strip master switch, indicator & intl. socket	686.00	05 / 50
9025	Titan 4 x 4 Power Strip individual switch, indicator & intl. socket	781.00	05 / 50
9026	F-Plus 4 x 1 Power Strip master switch & intl. socket	600.00	05 / 60

■ Red ■ Blue
■ Orange ■ Yellow

ZINE POWER STRIP (5Mtrs.)

9041	Qubic 4 x 1 Power Strip master switch, indicator & intl. socket	752.00	05 / 50
9042	Qubic 4 x 4 Power Strip individual switch, indicator & intl. socket	844.00	05 / 50
9043	Qubic 4 x 4 Power Strip with USB individual switch, usb port, indicator & intl. socket	1301.00	05 / 50
9044	Titan 4 x 1 Power Strip master switch, indicator & intl. socket	734.00	05 / 50
9045	Titan 4 x 4 Power Strip individual switch, indicator & intl. socket	832.00	05 / 50

CODE	ITEM	MRP(Rs.)	PKG OUTER / MASTER
------	------	----------	--------------------

ZINE ANGLE / BATTEN HOLDER (UNBREAKABLE)

9059	Gio Angle Holder	66.00	20 / 400
9060	Gio Batten Holder	66.00	20 / 400
9058	Gio Jumbo Batten Holder	77.00	20 / 400
9066	4G Angle Holder	79.00	20 / 400
9067	4G Batten Holder	79.00	20 / 400
9057	Brio Batten Holder	57.00	20 / 400
9056	Brio Jumbo Batten Holder	69.00	20 / 400
9069	Angle Holder	49.00	20 / 400
9070	Batten Holder	49.00	20 / 400
9073	Sleek Angle Holder	51.00	30 / 600
9074	Sleek Batten Holder	51.00	30 / 600
9071	Circular Pilot Ceiling Rose	51.00	30 / 600
9072	Jumbo Ceiling Rose	60.00	20 / 400
9075	Unique Ceiling Rose	40.00	40 / 800



ZINE SQUARE ANGLE / BATTEN HOLDER (UNBREAKABLE)

9081	Square Angle Holder	97.00	10 / 200
9082	Square Batten Holder	97.00	10 / 200
9083	Square Pilot Ceiling Rose	76.00	20 / 600
9084	Gio Square Angle Holder	91.00	10 / 200
9085	Gio Square Batten Holder	91.00	10 / 200
9086	5X5 Square Angle Holder	91.00	20 / 400
9087	5X5 Square Batten Holder	91.00	20 / 400
9095	5X5 Square Blank Plate	76.00	30 / 600

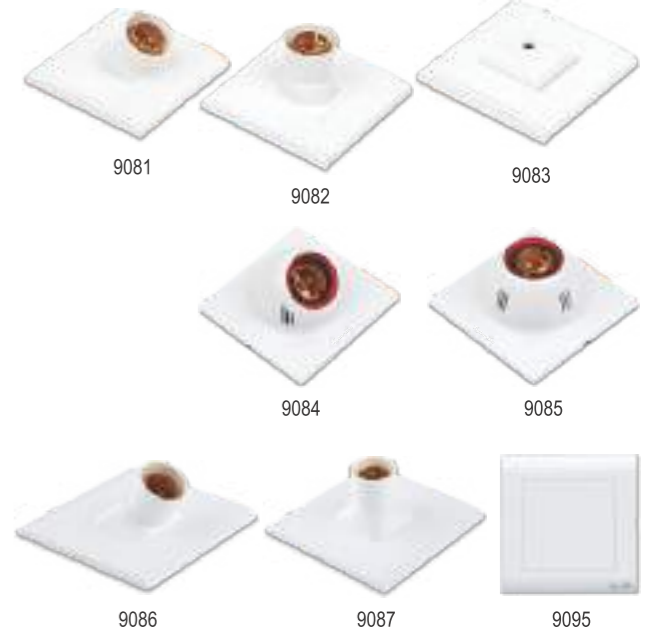



CODE	ITEM	MRP(Rs.)	PKG OUTER / MASTER
ZINE TWIST ANGLE / BATTEN HOLDER (UNBREAKABLE)			
9088	Twist Angle Holder	91.00	10 / 200
9089	Twist Batten Holder	91.00	10 / 200
9090	Twist Pilot Ceiling Rose	85.00	30 / 600
9053*	Zuri Angle Holder (New)	91.00	15 / 300
9054*	Zuri Batten Holder (New)	91.00	15 / 300

CODE	ITEM	MRP(Rs.)	PKG OUTER / MASTER
ZINE WIRE LINK 5 Mtrs. / STARTER			
9091	Wire Link 5 Mtrs. with 2 Pin Plug & Pendant Holder	190.00	10 / 160
9031	Nano 20/40W. Starter	16.00	100 / 1600

CODE	ITEM	MRP(Rs.)	PKG OUTER / MASTER
ZINE ROUND JUNCTION PLATES			
9096	Round Junction Plate size 3.5 inch	14.00	100 / 1600
9097	Fan Junction Plate size 6.5 inch	46.00	25 / 400
9098	Round Fan Junction Plate size 6.25 inch	69.00	25 / 400
9099	Round Batten Holder	102.00	10 / 200

CODE	ITEM	MRP(Rs.)	PKG OUTER / MASTER
VIVARIA CUBE WOOD PLATES			
V 4001	4.5 x 4.5 Plate	66.00	10 / 480
V 4002	4.5 x 6.5 Plate	89.00	10 / 480
V 4003	4.5 x 8.5 Plate	122.00	10 / 240
V 4004	4.5 x 10.5 Plate	171.00	10 / 240
V 4005	4.5 x 12.5 Plate	181.00	10 / 240
V 4006	4.5 x 15.5 Plate	214.00	10 / 240
V 4009	6.5 x 8.5 Plate	210.00	10 / 180
V 4010	6.5 x 10.5 Plate	250.00	10 / 180
V 4011	6.5 x 12.5 Plate	280.00	10 / 180
V 4014	7.5 x 10.5 Plate	298.00	10 / 120
V 4017	8.5 x 10.5 Plate	315.00	10 / 120
V 4018	8.5 x 12.5 Plate	332.00	10 / 120
V 4021	10.5 x 12.5 Plate suitable for wooden boxes	341.00	10 / 120

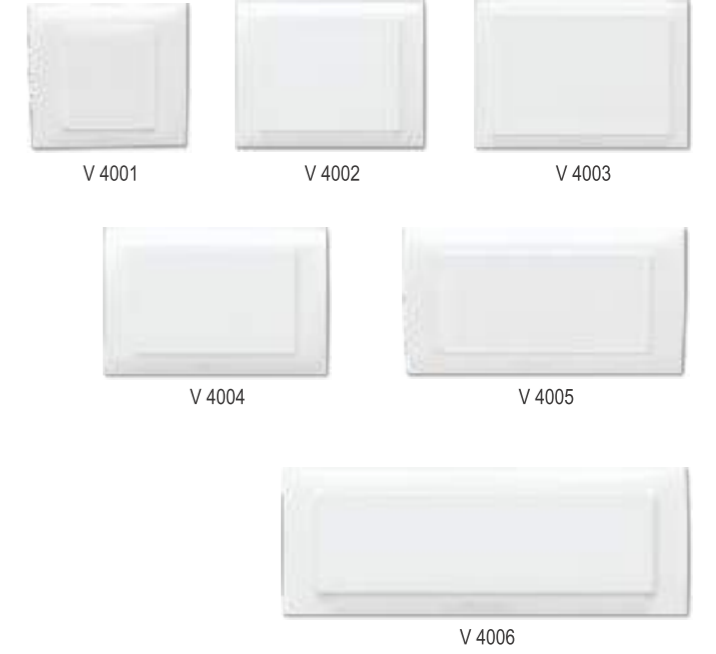



ZUNIX
POLYCARBONATE SERIES



ZUNIX

POLYCARBONATE SERIES

OUR CUTTING-EDGE ELECTRICAL ACCESSORIES RANGE, DESIGNED TO ENHANCE YOUR DAILY LIFE. DISCOVER A WIDE SELECTION OF INNOVATIVE AND RELIABLE PRODUCTS THAT SEAMLESSLY INTEGRATE INTO YOUR HOME OR OFFICE.

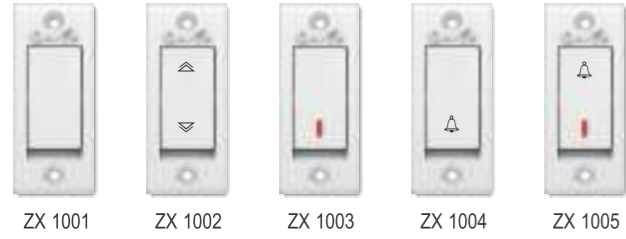

CODE	ITEM	MRP(Rs.)	WHITE / BROWN	PKG OUTER / MASTER
ZUNIX 6 AMP. NOVA SWITCHES				
ZX 1001	One Way Switch	37.00		20 / 1200
ZX 1002	Two Way Switch	46.00		20 / 1200
ZX 1003	One Way Switch With Ind.	47.00		20 / 1200
ZX 1004	Bell Push Switch	47.00		20 / 1200
ZX 1005	Bell Push Switch With Ind.	62.00		20 / 1200

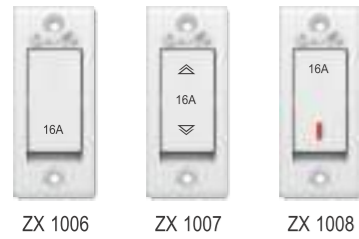

CODE	ITEM	MRP(Rs.)	WHITE / BROWN	PKG OUTER / MASTER
ZUNIX 16 AMP. NOVA SWITCHES				
ZX 1006	One Way Switch	65.00		20 / 1200
ZX 1007	Two Way Switch	76.00		20 / 1200
ZX 1008	One Way Switch With Ind.	76.00		20 / 1200



CODE	ITEM	MRP(Rs.)	WHITE / BROWN	PKG OUTER / MASTER
ZUNIX 6 AMP. NOVA GAMA SWITCH				
ZX 1009	Bell Push Switch With Ind.	71.00		10 / 600



CODE	ITEM	MRP(Rs.)	WHITE / BROWN	PKG OUTER / MASTER
ZUNIX 32 AMP. NOVA D.P. SWITCH				
ZX 1010	D.P. Switch With Ind.	202.00		10 / 600

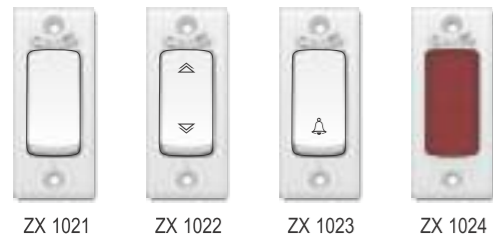

CODE	ITEM	MRP(Rs.)	WHITE / BROWN	PKG OUTER / MASTER
ZUNIX 6 AMP. OPUS SWITCHES				
ZX 1021	One Way Switch	33.00		20 / 1200
ZX 1022	Two Way Switch	39.00		20 / 1200
ZX 1023	Bell Push Switch	39.00		20 / 1200
ZX 1024	Indicator	39.00		20 / 1200

CODE	ITEM	MRP(Rs.)	WHITE / BROWN	PKG OUTER / MASTER
ZUNIX 6 AMP. SOCKET				
ZX 1032	3 Pin Socket	43.00		10 / 600



CODE	ITEM	MRP(Rs.)	WHITE / BROWN	PKG OUTER / MASTER
ZUNIX TV ANTENA / TEL. JACK / KITKAT FUSE				
ZX 1036	Mini Tv Socket	50.00		20 / 1200
ZX 1037	Mini 2 Line Tel. Jack With Enclosure	84.00		20 / 1200
ZX 1038	10Amp. Kitkat Fuse	52.00		10 / 600



CODE	ITEM	MRP(Rs.)	WHITE / BROWN	PKG OUTER / MASTER
ZUNIX DIMMER & REGULATOR				
ZX 1041	RIO Mini Dimmer	215.00		20 / 400
ZX 1042	RIO Medium Dimmer	224.00		10 / 300
ZX 1043	RIO 4 Step Regulator	297.00		20 / 400
ZX 1044	RIO 5 Step Regulator	340.00		10 / 300

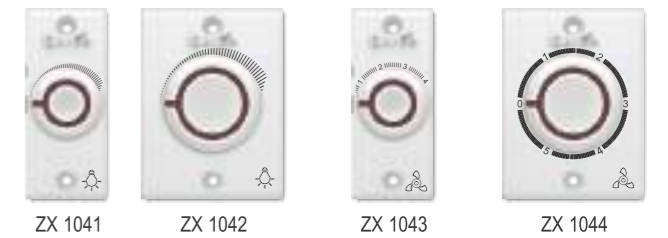

CODE	ITEM	MRP(Rs.)	WHITE / BROWN	PKG OUTER / MASTER
ZUNIX 6 AMP. S.S. COMBINED WITH JUNCTION BOX				
ZX 1051	6Amp. S. S. Combined with Ind.	99.00		05 / 200
ZX 1052	6Amp. S. S. Combined with Ind. & J. Box	112.00		05 / 200



CODE	ITEM	MRP(Rs.)	WHITE / BROWN	PKG OUTER / MASTER
ZUNIX 16 AMP. SWITCHES & SOCKET / 32 AMP. D.P. Switch				
ZX 1056	16Amp. One Way Switch (Dolly)	121.00		10 / 200
ZX 1057	16Amp. Two Way Switch (Dolly)	154.00		10 / 200
ZX 1058	6 & 16Amp. Universal Socket Without Shutter (Dolly)	121.00		10 / 200
ZX 1060	32Amp. D.P. Switch With Ind.	213.00		10 / 200





ZX 1061



ZX 1062



ZX 1063



ZX 1064



ZX 1066



ZX 1067



ZX 1068



ZX 1069



ZX 1071



ZX 1073



ZX 1076



ZX 1077

CODE	ITEM	MRP(Rs.)	WHITE / BROWN	PKG OUTER / MASTER
ZUNIX 16 AMP. 3 IN 1 WITH JUNCTION BOX				
ZX 1061	3 In 1 Uni. S. S. Combined (Dolly) - Ind.	219.00		05 / 100
ZX 1062	3 In 1 Uni. S. S. Combined With Junction Box (Dolly) - Ind.	231.00		05 / 100
ZX 1063	3 In 1 Uni. S. S. Combined With Safety Shutter (Dolly)	219.00		05 / 100
ZX 1064	3 In 1 Uni. S. S. Combined With Safety Shutter & Junction Box (Dolly)	231.00		05 / 100
ZUNIX 16 AMP. 5 IN 1 WITH JUNCTION BOX				
ZX 1066	5 In 1 Uni. S. S. Combined (Dolly) - Ind., Kit Kat Fuse	290.00		05 / 100
ZX 1067	5 In 1 Uni. S. S. Combined With Junction Box (Dolly) - Ind., Kit Kat Fuse	328.00		05 / 100
ZX 1068	5 In 1 Uni. S. S. Combined (Dolly) - Ind., Kit Kat Fuse & Safety Shutter	290.00		05 / 100
ZX 1069	5 In 1 Uni. S. S. Combined With Junction Box (Dolly) - Ind., Kit Kat Fuse & Safety Shutter	328.00		05 / 100
ZUNIX 6A. 6 IN 1 & 16A. 8 IN 1 WITH JUNCTION BOX				
ZX 1071	6 In 1 S. S. Combined With Junction Box (Dolly) - Ind.	300.00		05 / 100
ZX 1073	8 In 1 S. S. Combined With Junction Box (Dolly) - Ind.	456.00		05 / 60
ZUNIX HOLDER (UNBREAKABLE)				
ZX 1076	Pendent Holder	35.00		30 / 600
ZX 1077	Adaptor	33.00		30 / 1200