

apc

ALL PRODUCT CATALOG

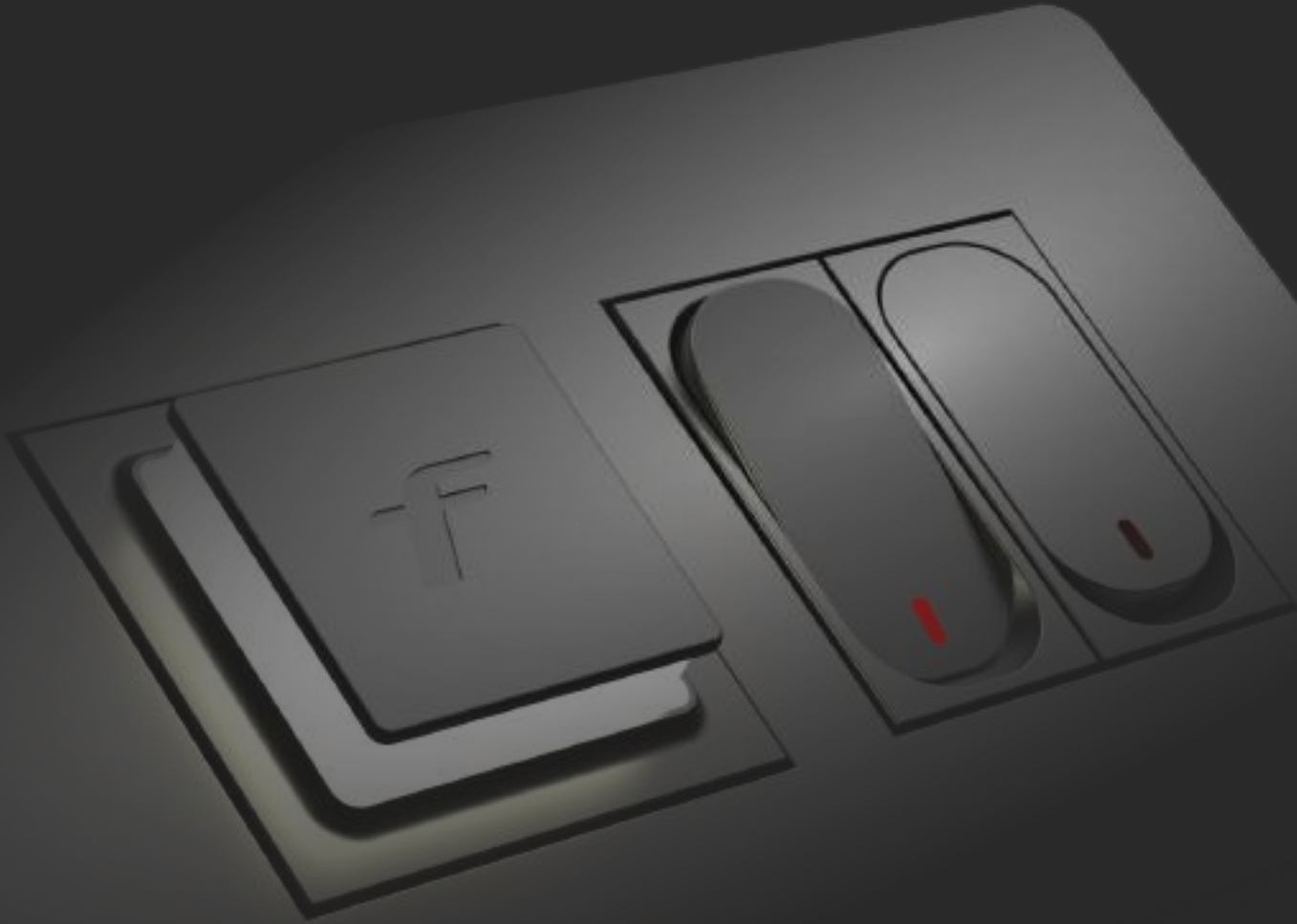

2024
P R O D U C T I O
P O R T F O L I O

TIME TO
REINVENT

At FybroS, we manufacture unparalleled

quality products such as

Wires & Cables, Switches & Accessories, Switchgears, Lighting Systems & Fans

Our brand has earned tremendous respect from all sections of society & businesses and has become synonymous with quality. We consider technology & innovation as one of our key pillars of growth. Therefore, we substantially invest in our R&D department to comply with the industry standards and modernize our products. We thrive on making an impact with our products.

FybroS caters to its customers in every space with contemporary, stylish, and finest quality electrical solutions that are highly praised and loved by everyone

because we believe in the saying-

"My Style, My Choice."



CONTENTS

01

SWITCHES & ACCESSORIES

Switches and accessories are essential components of electrical systems, facilitating control and convenience in lighting and power usage. Available in various types such as toggle switches, dimmers, and motion sensors, they offer flexibility and customization for different needs. With advancements like smart switches integrating with home automation systems, users can enhance energy efficiency and convenience through remote control and scheduling features.

02

WIRES & CABLES

Electrical fans, ubiquitous in modern households, offer efficient air circulation for comfort and ventilation. With various types including ceiling fans, desk fans, and tower fans, they cater to diverse needs and spaces. Powered by electricity, they provide cooling relief in hot climates and aid in maintaining air quality indoors.

03

LIGHTING SYSTEMS

LED lights, revolutionizing the lighting industry, boast remarkable energy efficiency and longevity compared to traditional bulbs. Emitting bright, clear illumination, they come in diverse colors and designs, suitable for various applications from residential to commercial settings. Their eco-friendly nature and reduced maintenance requirements make them an increasingly popular choice for modern lighting solutions.

04

SWITCHGEARS

Switchgears are crucial electrical devices used to control, protect, and isolate electrical equipment in power systems. They play a pivotal role in ensuring the safety and reliability of electrical networks by interrupting or diverting electrical currents when necessary. Available in various types such as circuit breakers, fuses, and switches, switchgears are vital components in industrial, commercial, and residential applications, safeguarding equipment and preventing potential hazards.

05

FANS

Electrical fans, ubiquitous in modern households, offer efficient air circulation for comfort and ventilation. With various types including ceiling fans, desk fans, and tower fans, they cater to diverse needs and spaces. Powered by electricity, they provide cooling relief in hot climates and aid in maintaining air quality indoors.



FOUR-X
MODULAR SERIES



Grace Switch

Sharp contours, distinct cuts, and smooth surface. Making the ordinary simply extraordinary. The switch deserves to grace your aesthetically designed walls



Glide Switch

Aesthetically designed with curved contours, the switch literally makes your finger glide upon touching its smooth surface. Just perfect to complement your designer walls.

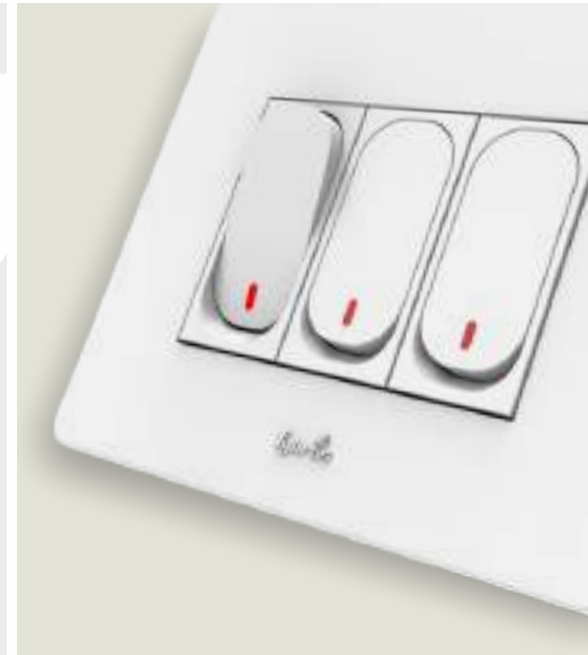

Glam Switch

With their sleek design, they add a touch of sophistication and elegance. The unique bar-shaped switches are ergonomic and also adds a visual treat to any modern interior.



F-touch Switch

The Magic Touch Style and functionality designed around you. The gentle touch of your fingertips lets you switch on to a world you can call your very own.

FOUR-X
MODULAR SERIES

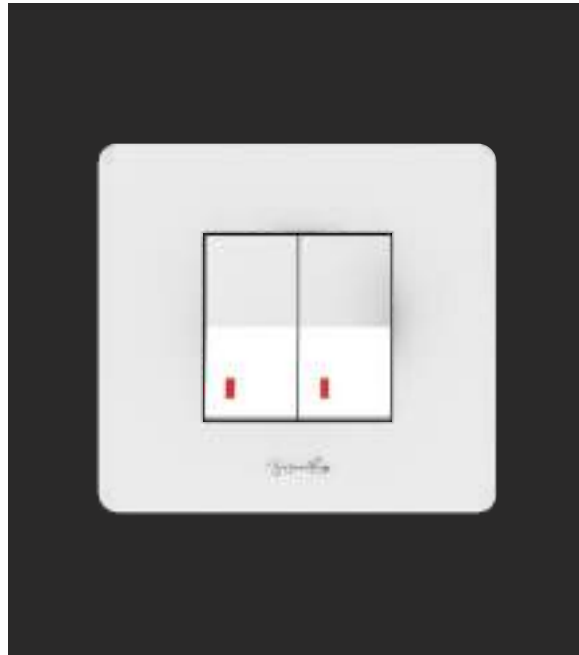

SERIES 5
MODULAR PLATE

The Four-X is a series of products which keeps reinventing itself to adapt to the modern demands of life. A range of avant garde switches, it provides a lifestyle that is on another dimension.



SERIES 3
MODULAR PLATE

Let style meet perfection! The new Series 3 modular plates come with sharp-curved edges that fit perfectly on the walls and compliment your home interior even more. Available in different colour options, series 3 includes the best-in-class switches that add meaning to beautification.

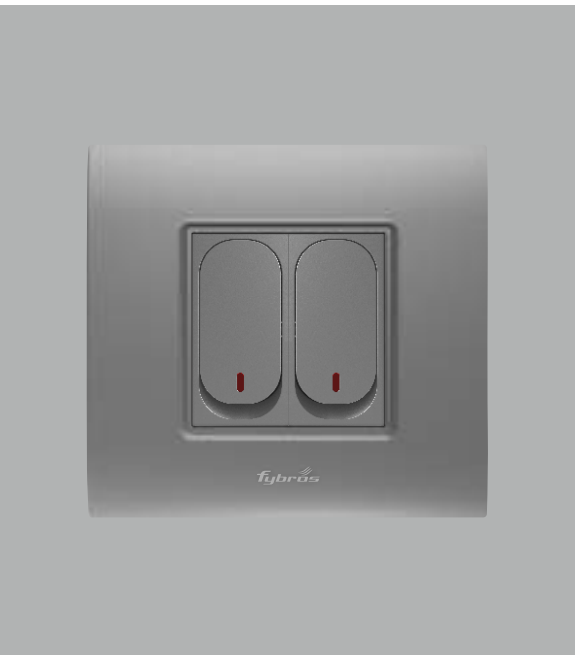

Devices

We have an exciting range of products that are stylish as well as vast. It ranges from modular switches to sockets to fan regulators and a multitude of devices. Designed with passion, we are motivated by the desire to create the best products possible that are versatile and made for everyday living that satisfies everyone's needs.



32A DP Main Switch
With Key Tag

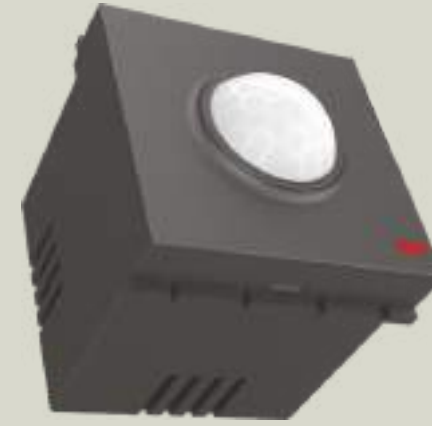

Motion Sensor



ORO
5 Step Regulator

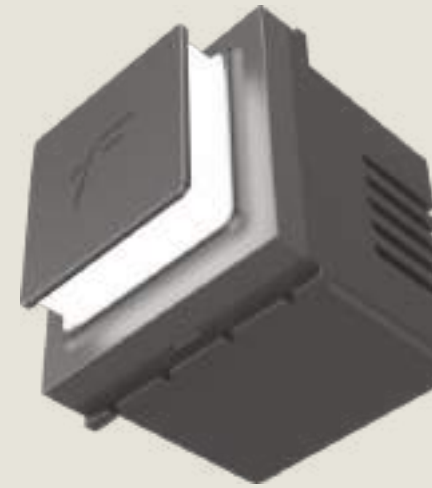

Pop-out Night Lamp



Motor Starter

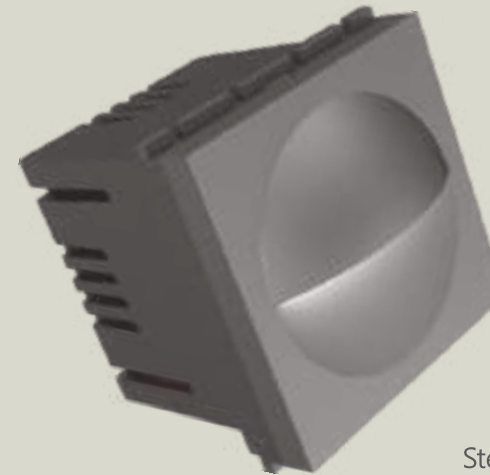

Step Marker



Accessories

With deep user insights and relentless research, we are able to build truly excellent products. Our accessories are an example of our commitment to quality and customer satisfaction. They are designed to perform and deliver on their intended promises. Every accessory is an example of excellence in ideas that excite your imagination.

Make 'Em Stare



Compact and Stylish, the Series-7 Wood Suitable Plates are a perfect blend of flair and aesthetics. Comes in a curved shape and is an accurate fit for wooden boxes. Install the Series-7 Wood Suitable Plates and make the visitors cherish the perfection.

SERIES 7
MODULAR PLATE

Redefining Luxury

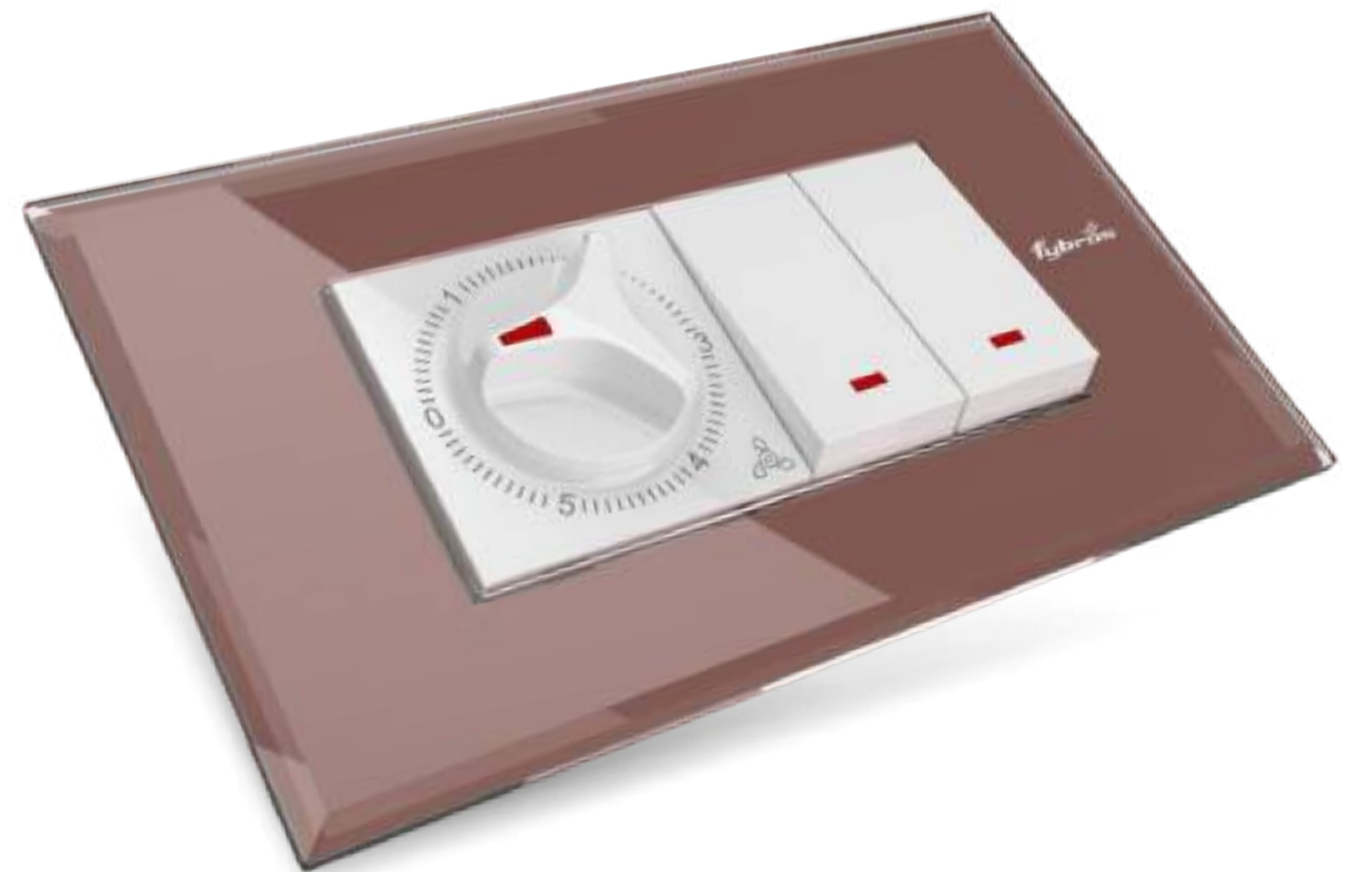

Art meets impression. With its sleek and minimalistic design, add a touch of elegance and grandeur with our Series-9 sleek Glass plates that will reflect your panache of life.

SERIES 9
GLASS PLATE

TIME TO
REINVENT



Crafted to elevate the ambiance of your interiors!
Meticulously designed from premium materials, our
cover plates embody sophistication and refinement.
Embrace the perfect combination of functionality
and aesthetics with our elegant Series II cover plates.

SERIES II
MODULAR PLATE



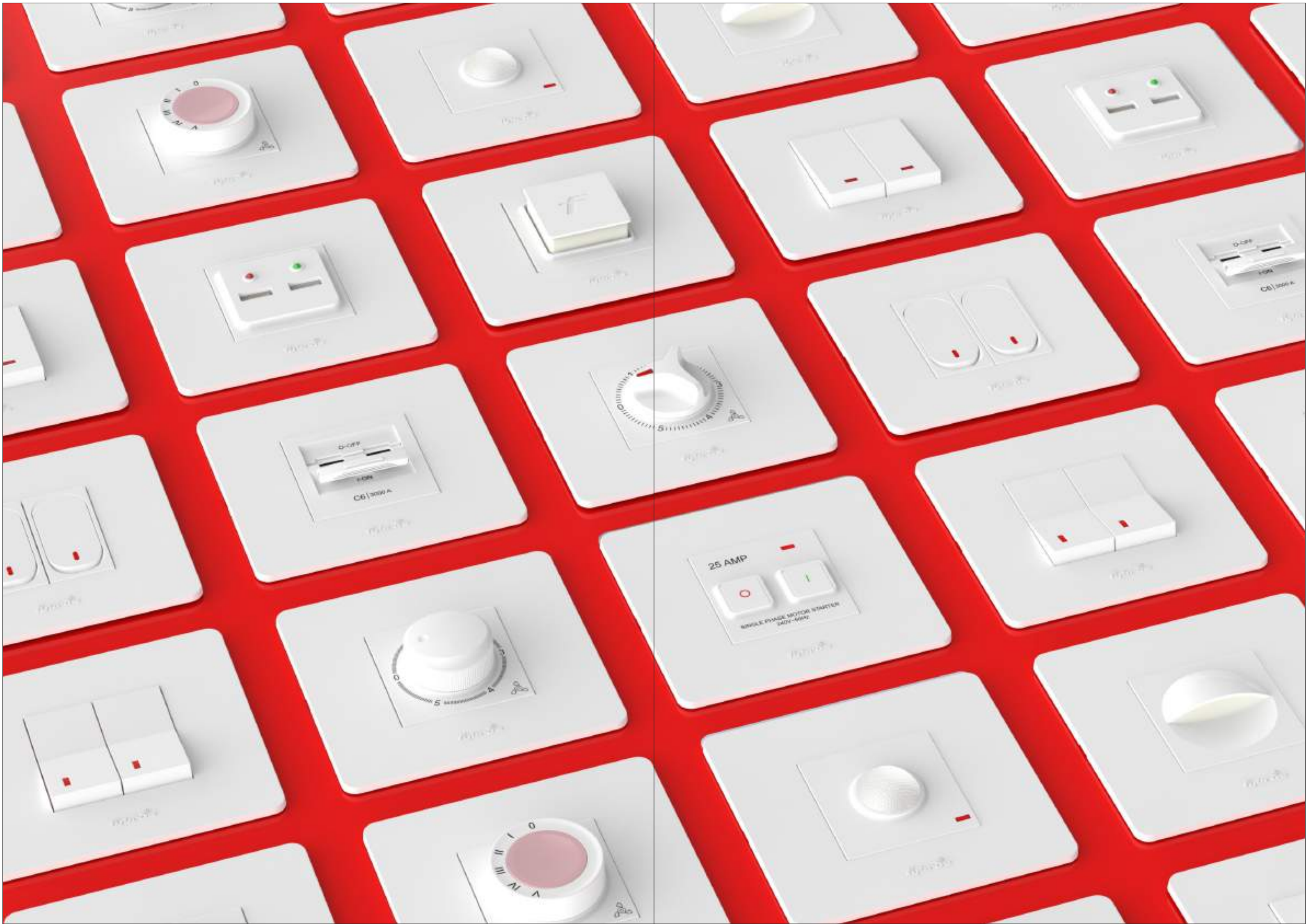

VERTICAL



FUSION | METTALIC
ULTRA SLIM PLATE

For those on the lookout for contemporary designs that are simple yet stylish. These metallic-finished modular plates are a natural extension of today's meticulously designed contemporary homes. This range represents designs that meet the discerning needs of a modern lifestyle.

FLORENZA
CURVE SLIM PLATE
Cynosure of all eyes

With their relaxed and friendly contours, these wood finished modular plates are unmistakably easy on the eye. But that's just the first impression. A closer look reveals the magnetic appeal of these perfectly shaped cover plates with gentle curves. Soothing yet energetic, sensuous yet practical, these switches are one compelling presence on your designer walls.

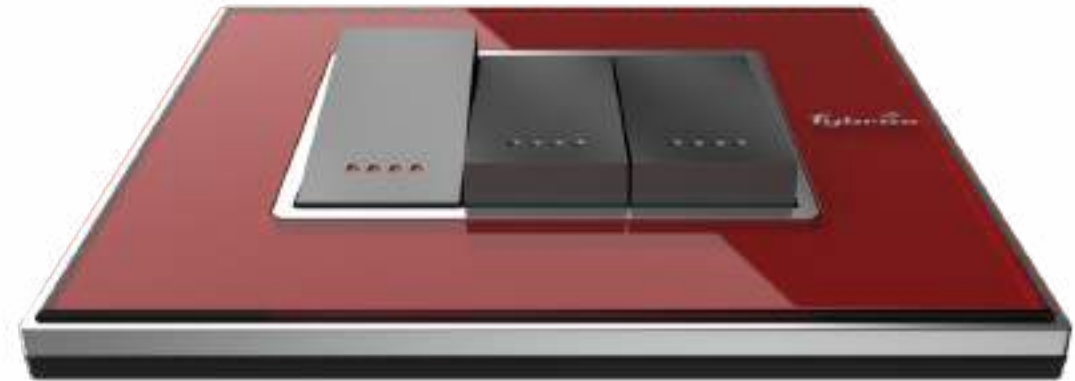

Fpace
CRYSTAL PLATE

The tantalizing attraction of pure glass can be an integral part of your home. The modular plates with spectacular glass finish add a lot of gloss to home decor. Succumb to the smooth contours and the alluring appeal.

So, switch to glass to enhance their class.

FLARE
MODULAR PLATE

FLARE Modular plate switches allow you to make bold statements by adding minimalistic hues. The classic finish sits smugly in the background, giving your interiors a perfect designer look.





F-WOOD
MODULAR PLATE

F-WOOD creates style statements that you can call your own. The perfect metallic finish modular plates add grace to your interiors, and the elegant simplicity of the designs lends sophistication. A great opportunity to express your discerning taste for others to follow suit.



fpacE | LEATHER
CLASSIC LEATHER PLATE

Walls with a sartorial elegance

X1 Switch with 3M Leather Plate



Switch X1
Delight for senses

The smooth flow, the perfect shape, and the distinctive curve of the switch is what makes it imperative for your modern home. The slender appearance adds that style quotient to your designer walls, cares the switch with your finger and delights your senses.

X2 Switch with 3M Leather Plate



Switch X2
Elegance is timeless

Today, indulgence is an essential requirement of life. What you indulge in reflects your personality and way of life. Beautifully designed, these switches are seamlessly aligned with the leather-finished modular plates, thereby enriching the aesthetics of your rooms, office, and cabin space. Experience sophistication and fitness like never before.

X3 Switch with 3M Leather Plate



Switch X3
Make a style statement

Unmistakably unique and distinctively stylish, this switch is perfect for adorning your home and office walls. The switch inclines itself while aligning itself straight when switched on or off. Designed in a shade that's subtle yet inimitable. After all, you deserve all the good things life has to offer.



AIR

MODULAR PLATES

AIR is a classical creation, displaying a smooth, glossy frontage with bevelled edges and a sophisticated yet warm and inviting demeanour. The elegantly designed corners radiate and absorb light, adding depth and character to the switches. Perfect art for the walls.

ARROW

MODULAR PLATES

Feel the essence of modernity on your walls. A design that captures every sight and finish that feels premium when touched. Available in alluring wood color, these modular switch plates enhance your interiors on a different level.



ASTRA

MODULAR PLATES

With its gently curved corners and chic, modern appearance, the ASTRA cover plate radiates an air of refinement and grace. It is an ideal complement to any contemporary decor, imbuing the space with a sense of sophistication and elegance. Its simple yet luxurious aesthetic is sure to upraise any decor.



Stella

Extension Cords
3 Pin 1.5 Mtrs. / 2 Pin 2.5 Mtrs.
With Indicator &
international Socket

Curve
spike guard

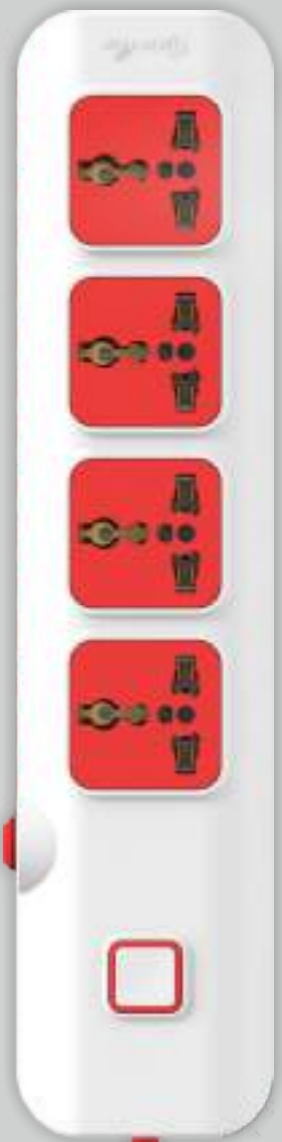

better connectivity

A range that includes a wide variety of products designed to complement and enhance the functionality of electrical systems. They are available in various styles, sizes, and designs to meet the needs of different applications and environments. Power up your space with our electrifying accessory range!



ELVIS
Stereophonic
Ding Dong Bell



FIONA
Stereophonic
Ding Dong Bell



GLOW
NIGHT LAMP



Shine
Night Lamp



SHINE
SWITCHES
& 2 IN 1 SOCKET WITH

SLIQ
3 PIN TRAVEL UNIVERSAL
MULTI PLUG WITH INDICATOR

WIRES & CABLES

FEEL PROTECTED FOR LIFE



FR

FR - FLAME RETARDANT (MULTISTRAND) PVC INSULATED INDUSTRIAL CABLES

FYBROS introduces FR wires, multi-strand flexible FR PVC Insulated building wires with fire retardant properties. The conductor is insulated with a specially formulated Flame Retardant FR grade PVC Compound having high insulation resistance, oxygen, temperature index and dielectric strength which prevents the leakage of electric current. Suitable for use in surface mounted or embedded conduits or trunking. Also suitable for field protected installation in lighting fittings and inside appliances.



UFFR

Ultra Flexible Flame Retardant PVC INSULATED INDUSTRIAL CABLES

Made with superior flexibility, high dielectric strength and soft annealed electrolytic grade copper having 99.97% purity with added triple layer protection against electric shocks, short circuits and fire. It has multipurpose applications like homes, offices, multi-storeyed buildings,



FR-LSH

Flame Retardant Low Smoke Halogen PVC INSULATED INDUSTRIAL CABLES

FR-LSH has special flame retardant, low smoke emitting and toxic fumes suppressing properties. The oxygen index of a FYBROS Wires have 32% which increases its efficiency in fire fighting. In the case of fire, conventional PVC insulated wires give out thick black smoke and toxic fumes of hydrochloric acid gas. This impairs visibility and hampers rescue operations. Not only emits very little smoke and toxic gases, but also retards the spreading of fire. The conductor manufacture of Pure Electrolytic Grade, bright annealed bare copper having very low resistance with more than 100% conductivity



CO-AXIAL CABLES

GAS INJECTED PHYSICAL FOAM JELLY FLOODED INDUSTRIAL CABLES

The central conductor of these cables is made of solid bare electrolytic grade 99.97% pure copper. The secondary conductor is specially designed with poly aluminium tape, applied longitudinally which overlaps and is bonded on the foam dielectric. ATC copper wires are braided and applied for aluminium tape specified coverage. The cable is then jacketed with a special long lasting UV resistant PVC compound. All Customers specifications are available. These cables are used for transmission of Video and Audio signals



COMPUTER & LAN NETWORKING CABLES

Networking data CAT-6 offered by us are precision designed to meet the requirements of horizontal distribution and backbone cabling. These can be made available in form of 100 Base TX, 100 Base VG Anylan, 155 ATM, IEEE 802.3, IEEE 802.5, 16 Mbps Token Ring, 622 ATM, Gigabit Ethernet and others. These cables form the backbone of modern data transmission in commercial areas, industries and



TELEPHONE & SWITCHBOARD

PVC INSULATED INDUSTRIAL CABLES

Made of pure electrolytic grade bright annealed bare copper as per IS:8130 in 0.4 mm, 0.5 mm. The insulated cores are twisted to form pairs and bunched to minimize cross talk. The cores are helically wrapped. Non hygroscopic and non wicking polyester tape or tape to form laid up cables. The laid up cables are further jacketed with grey colour and high oxygen index fire retardant PVC. FYBROS Telephone and Switchboard cables are recommended for switchboard and internal telephone wiring in multi-storeyed buildings,



SWITCHGEARS

FOR A SMARTER AND SAFER WORLD

MAGNA DISTRIBUTION BOARDS

Designed with a new Magnetic look, the Magna Distribution Boards by Fybrós are equipped with an insulated Copper Bus Bar rating up to 100A that prevents short circuit current and holds ample wiring space to ensure proper distribution of Neutral and Earth wires. These Distribution Boards are completely shockproof by earthing on the door for extra protection.



RATINGS	TYPE	IP
4 - 16 Way	SPN/TPN/PH.SEL (SD, DD)	21

INSPIRO DISTRIBUTION BOARDS

The INSPIRO range of distribution boards are elegant in its looks. They fit in perfectly with the interiors of your homes, adding to the aesthetics. The designer DBs serve a dual purpose. They save you from the harmful effects of current and make your walls magnificent.



RATINGS	TYPE	IP
4 - 16 Way	SPN/TPN Metal Base & Plastic Base	21

ELITE DISTRIBUTION BOARDS

A Distribution Board (also known as panel board, breaker panel, electric panel or DB) is a component of an electricity supply system that divides an electrical power feed into subsidiary circuits, while providing a protective fuse or circuit breaker for each circuit in a common enclosure. The interior of the distribution board is pre-fitted with a clip tray or DIN rail for mounting the miniature circuit breakers (MCB) and other devices.



RATINGS	TYPE	IP
4 - 16 Way	SPN	21
4 - 12 Way	TPN	21

WATER - PROOF SUBMERSIBLE PUMP CABLES

Manufactured from bright-annealed 99.97% pure bare copper conductors, these cables have low conductor resistance. The inner cores are insulated with a special grade PVC compound formulated and manufactured in-house. The tough robust outer PVC jacket protects it from the oils, greases, various chemicals and abrasions, thereby giving long life and electrical safety.



SINGLE & MULTICORE CABLES

FYBROS Insulated/sheathed Multicore Cables with flexible conductor are manufactured under most stringent quality control measures to ensure total safety, prevention of shock hazards, less possibility of fires and complete assurance for perfect system. These cables are manufactured from 99.97 % pure bare flexible electrolytic grade copper conductor and low conductor resistance which are insulated with special grade PVC Compound and manufactured in-house. These cables are mostly used for wiring in machines, control panels, Electric power supply, modern electric appliances and equipment.

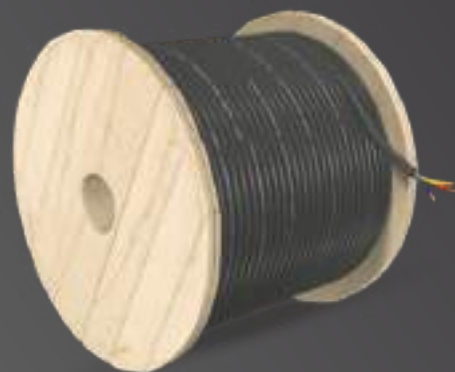

LT-POWER CONTROL CABLES XLPE/PVC Insulated Cables

LT Power & Control Armoured Cables are available in different combinations such as Aluminium conductor, Copper conductor, Round Solid conductor, stranded sector shaped conductor PVC/XLPE Insulated, Taped/Extruded inner sheath, Galvanized steel Round Wire/Strip and Aluminium Round Wire / Strip armoured / unarmoured outer sheathed Cable etc. LT/PVC/XLPE Power Cables are used for underground as well as for overhead transmission of power in Power Plants, Industries and various other projects.





ARMOR Miniature Circuit Breaker (MCB)

ARMOR MCB (Miniature Circuit Breaker) is made of thermo-magnetic, current limiting type and is available with type C operating characteristics. We use Miniature circuit breakers in low voltage electrical networks instead of fuse. It automatically switches off the electrical circuit during abnormal conditions such as short circuits, overloads, and faulty conditions. ARMOR MCBs are used for residential and industrial purposes.

RATINGS	TYPE	IP
6 - 63 Amp.	SP/SPN/DP TP/TPN/FP	20

ARMOR Isolator

ARMOR ISOLATOR are switch disconnectors with independent manual operation, capable of making, carrying and breaking currents under normal circuit conditions. It can also operate under overload conditions and carry currents under specified abnormal circuit conditions, such as short circuits for a specified time.

ARMOR ISOLATORS are used for residential and industrial purposes.

RATINGS	TYPE	IP
25 - 100 Amp.	DP/TP/FP	20

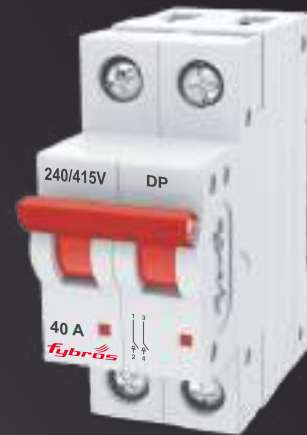

ARMOR Residual Current Circuit Breaker (RCCB)

ARMOR RCCB (Residual Current Breaker) is an electrical wiring device that disconnects a circuit whenever it detects that the electric current is not balanced between the phase (hot) conductor. RCCB is an essential current sensing equipment that guards a low voltage circuit against the fault. It comprises a switch device to turn off the circuit when a fault occurs. Fires and electrocution are caused due to the wrong wiring or any earth faults. RCCB is also known as ELCB (Earth Leakage Circuit Breaker).

RATINGS	TYPE	IP
25 - 100 Amp. (30mA/100mA/300mA)	DP/FP	20

ARMOR Mini Changeover Switch

ARMOR Mini Changeover Switches are disconnectors with independent manual operation. These Changeover Switches can make, break and carry currents under normal load conditions. ARMOR Mini Changeover Switches should be backed by a suitably rated MCB or fuse that breaks the circuit in case of heavy current faults.

RATINGS	TYPE	IP
25 - 63 Amp.	DP/FP	20



Total Safety

ReNOVE

Rewireable Switch Fuse (Single Break)

RENOVE Re-wireable Switch Fuse single break used for distributing power, protecting electrical devices and cable from damage due to power fluctuations. This Fuse single break is housed using a quality CR sheet in an enclosure. The fuse single break stringently tested compliance with the standards IS/IES - 60947-3. It has a breaking capacity of 4 kA. Switch fuse single break is used for industrial and domestic purpose.

RATINGS	TYPE	IP
16 - 63 Amp.	SPN/DP TPN/FP	23



RATINGS	TYPE	IP
16 - 200 Amp.	SPN/DP TPN/FP	23

NUEVO

Rewireable Switch Fuse (Single Break)

NUEVO

Changeover Switch (Off Load)

NUEVO Off Load Changeover Switch has a side handle operation that can be used in all general industries where individual systems require safe and reliable power transfer from the main supply to standby and vice versa. Off Load Changeover Switches are supplied in CR sheet enclosure, side operated with three stable positions; LO-II (Center-off-position). This is the type of changeover in which time delay is provided with the help of a unit so that after the changeover between supplies, the load is connected to another supply source after a particular time delay.

RATINGS	TYPE	IP
32 - 320 Amp.	DP/TP/FP (U Type & Knife Type)	23



RATINGS	TYPE	IP
32 - 63 Amp.	DP	23

ReNOVE

Changeover Switch (Off Load)

RELIABLE & POWERFUL



NUEVO RREWIRABLE KIT KAT FUSE UNIT

Porcelain Fuse Units (Kit Kat) are semi enclosed fuse or re-wireable fuse specifically utilized in industrial, commercial and domestic electrical fittings for ensuring flawless power distribution. There are two parts: fuse carrier wire and fuse base. The fuse wire is attached to fuse carrier which can be removed or connected to fuse base. The phase wire is permanently connected to fuse base. The phase wire is permanently connected to fuse base. Its short circuit breaking capacity 4kA.

RATINGS	TYPE	IP
16 - 500 Amp.	PILOT, EXCELL TURBO	20



WAVE PLUS

Modular Plug & Socket Enclosure (with Mini MCB)

Wave Plus Modular Plug & Socket Enclosure (with Mini MCB) are elegantly designed to suit your home's decor and protect home appliances like ACs, Geysers, Microwaves & Computers, etc.

RATINGS	TYPE	IP
25 Amp.	4 Module	20



RENOVE Mini MCB with Enclosure

The RENOVE Mini MCB by Fybros is compact and has an elegant enclosure. It provides protection from overload and short circuits with its breaking capacity of 3kA. These MCBs have a sleek power supply indication that keeps you informed about being in an ON position.

With RENOVE Mini MCB safety is assured at all times in condition of short circuits and this Mini MCB is capable of quick and easy installation.

RATINGS	TYPE	IP
32 Amp.	DP	20



NUEVO REVERSE FORWARDING SWITCH

NUEVO Reverse Forwarding Switch is an electric switch with four terminals capable of being connected in pairs in two different ways to reverse the direction of current flow. Reversing Switch is a widely demanded installation in various devices to control their reverse operation. Reverse Forward Power Control Switches are widely acclaimed due to their reliability.

RATINGS	TYPE	IP
16 - 32 Amp.	Metal Handle & Plastic Handle	23



NUEVO BUS BAR CHAMBER

NUEVO Busbar Chamber System is designed for safe, reliable & economical power distribution to various loads per the system's requirements. Busbar is a metallic strip or bar, typically housed inside switchgear, panel boards, and busway enclosures for local high current power distribution. They also connect high-voltage equipment at electrical switch yards and low-voltage equipment at battery banks. They are generally uninsulated and have sufficient stiffness to be supported in the air by insulated pillars.

RATINGS	TYPE	IP
32 - 630 Amp.	4 Way	23



MAGNA CAM OPERATED ROTARY SWITCH

MAGNA Cam Operated Rotary Switches are used for making/breaking and Isolating power circuits and switching auxiliary circuits. These cam-operated rotary switches are known for their high flexibility, easy handling, solid rigidity and reliability. Cam-operated rotary switches are manually operated and assembled on packet principle, giving a choice of multi-position and multi-pole circuits.

RATINGS	TYPE	IP
25 - 63 Amp.	'T'	10





JOY OF USE

Experience our OPAL COB Down lights, perfect and elegant. Compliments any decor with its changeable colour options. Suitable for living rooms, showrooms, and restaurants.

Simple yet joyful.



ROSE GOLD METALLIC SILVER METALLIC BLACK



OPAL COB SPOT LIGHTS

WATT	CUT SIZE in (mm)	STD. Pkg. in Pcs.
8W	55	20
15W	75	20



Lights That Set Your Mood Apart

With Fybras COB lights the optics produce the quality of light that inspires. It allows people to shape the lightscapes of their personal space. You can sit back relax or get the party started with our multiple COB light options available in different colours and designs.

F-RING LED SPOT LIGHTS

WATT	CUT SIZE in (mm)	STD. Pkg. in Pcs.
2W	35	100

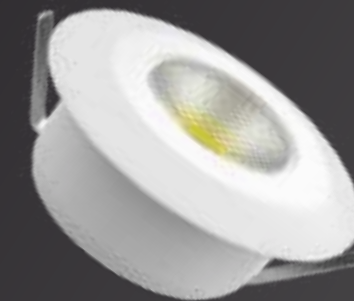

NEO COB SPOT LIGHTS

WATT	CUT SIZE in (mm)	STD. Pkg. in Pcs.
3W	45	100



PACE COB SPOT LIGHTS

WATT	CUT SIZE in (mm)	STD. Pkg. in Pcs.
5W	55	50
10W	75	50
15W	90	20
25W	115	20
35W	130	20





HYBRID L A M P S



WATT	TYPE	STD. Pkg. in Pcs.
0.5W	B-22	60
3W	B-22	50
5W	B-22	50
7W	B-22	50
9W	B-22	50
12W	B-22	50
16W	B-22	50
20W	B-22	30
30W	B-22	12
40W	B-22	12
50W	B-22	6
60W	B-22	6



While an ordinary LED lamp has 180 degree beam angle, Fybrós HYBRID LED lamp comes with a 240 degree angle. The excess of 60 degree translates into 33% more light. Our HYBRID range of lamps is based on thermal fold back technology, which ensures long life and energy saving capacity.

Salient features

- IP-20
- Wide Beam
- High Output 100 Lm/Watt



BLOOM
NIGHT LAMPS
0.5W

GO FOR THE SMARTEST LIGHTING SOLUTIONS

LED Batten is slimmer and shorter than regular tube lights, making it easier to install. It produces less heat, is eco-friendly, and has a longer lifespan than regular fluorescent tube lights. Moreover, it does not radiate any UV rays.

CASA T5/T8 WALL LIGHTS

WATT	SIZE	STD. Pkg. in Pcs.
5W	1 FT	25
10W	2 FT	25
20W	4 FT	25
25W	4 FT	25
36W	4 FT	25
45W	4 FT	25



LINC T5 WALL LIGHTS

WATT	TYPE	STD. Pkg. in Pcs.
6W	1' T5	40
12W	2' T5	40
22W	4' T5	40



THE FINE ART OF LIGHT



GAZE MINI WALL LIGHTS

WATT	TYPE	STD. Pkg. in Pcs.
1X6W	WALL LIGHT	40

W Y



GAZE UP DOWN WALL LIGHTS

WATT	TYPE	STD. Pkg. in Pcs.
2X6W	WALL LIGHT	20

W Y



LYSA BULK HEAD LIGHTS

WATT	SIZE (mm) (LXWXH)	STD. Pkg. in Pcs.
10W	170X70X48	40
20W	210X100X60	20

CW NW WW

Aesthetics meets functionality...



ROSO JUNCTION DOWN LIGHTS

WATT	CUT SIZE in (mm)	STD. Pkg. in Pcs.
8W	50	40
15W	50	20

W R B Y G P



IMPEL SURFACE PANELS

WATT	SIZE (mm) D X H	STD. Pkg. in Pcs.
8W	80 X 40	40
15W	135 X 40	20

CW NW WW



KEYA FRAMELESS SURFACE PANELS

WATT	SIZE (mm) D X H	STD. Pkg. in Pcs.
6W	90 X 27	40
12W	120 X 27	20
18W	155 X 27	20
24W	190 X 27	20

CW NW WW

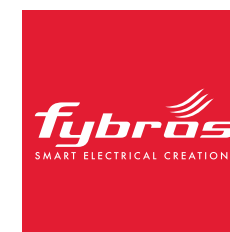



DAYLIGHTS AT NIGHT



ALORE STREET LIGHT

ALORE LED Street Lights ensure lighting that brightens your patio, streets or any large spaces with ease.

WATT	TYPE	STD. Pkg. in Pcs.
20W	LENS	20
24W	LENS	20
30W	LENS	20
36W	LENS	20
50W	LENS	10
100W	LENS	10



LUMOS

WALL/ STREET LIGHTS

LUMOS Wall / Street Lights are a reliable lighting solution for any environment, from dark tunnels to large spaces like airports.

Certified with an IP65 rating, these lights are dust and water-resistant, making them suitable for use in any weather condition.

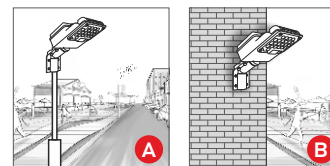

Fig. A - POLE MOUNT Fig. B - WALL MOUNT

WATT	TYPE	STD. Pkg. in Pcs.
15W	LENS	20
25W	LENS	20



WAKE UP TO RADIANCE

LED Floodlights are the most preferred choice as they last long and consume less electricity as compared to standard incandescent light sources, CFLs or Halogen lights. So, they illuminate larger areas without being too expensive.



ZIVA FLOOD LIGHTS

WATT	TYPE	STD. Pkg. in Pcs.
15W	GLASS	20
30W	GLASS	20
50W	GLASS	10
100W	GLASS	10
150W	GLASS	5
200W	GLASS	5
300W	GLASS	2
400W	GLASS	2
500W	GLASS	2



PRISCA FLOOD LIGHTS

WATT	TYPE	STD. Pkg. in Pcs.
30W	LENS	20
50W	LENS	10
100W	LENS	10
150W	LENS	5
200W	LENS	5





CUBE

ELEGANT PANELS

Cube elegant panels are perfect for modern homes and offices, with a simple yet modern design. The panels are made of PC body material, which makes them easy to install. The use of high-quality LED chips ensures that the light produced is as brilliant as sunlight.



WATT	CUT SIZE in (mm)	STD. Pkg. in Pcs.
8W	100	40
15W	150	20
22W	200	20



Wake-up to Eco friendly lighting

WAVE

ULTRA SLIM PANEL

WATT	CUT SIZE in mm	STD. Pkg. in Pcs.
4W	75	40
6W	100	40
10W	125	40
15W	150	20
22W	200	20
30W	300	10



F-GLO

FLEXIBLE STRIP LIGHTS

Strip lights have become a popular choice for festive occasions and home decor. The LEDs come in durable, compact packages that are shock-resistant and can be used in multiple ways. Available in long strip lengths, these LED strips come in a variety of single colors as well as multi-color options (RGB). Strip LEDs are cost-effective and easier to install.

2835 SMD | 60/120/180/240 LED PER METER | IP20 | 5 METER LENGTH



F-GLO

FLEXIBLE ROPE LIGHTS

2835 SMD | 60/120 LED PER METER | IP65 | 25/50 METER LENGTH

FLEXIBLE NEON ROPE LIGHTS

2835 SMD | 120 LED PER METER | IP65 | 50 METER LENGTH

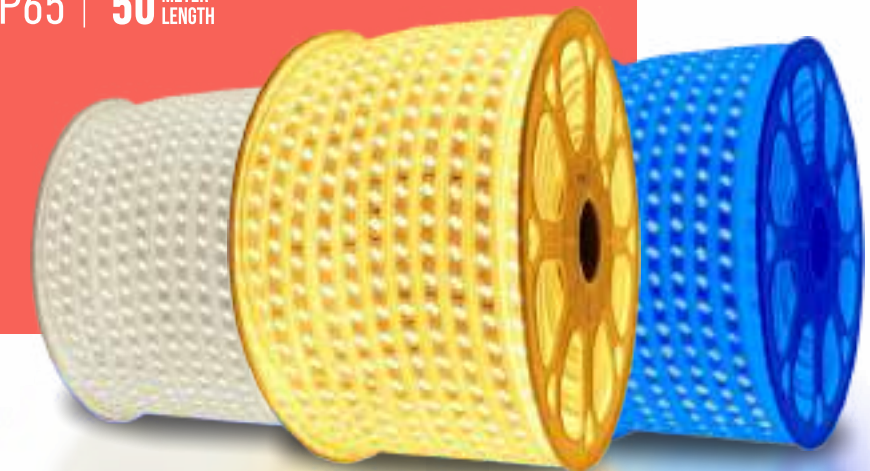



F-SQUARE

PANEL LIGHTS

WATT	TYPE	STD. Pkg. in Pcs.
40	SQUARE	6

CW NW WW

SIRIO

COB SURFACE LIGHTS

WATT	TYPE	STD. Pkg. in Pcs.
8W	ROUND/SQUARE	20
16W	ROUND/SQUARE	20



ROSE GOLD



METALLIC BLACK

CW NW WW



SLEEK
DESIGN
BRIGHT
LIGHT



CANDY

STREET LIGHT

WATT	TYPE	STD. Pkg. in Pcs.
24W	LENS	20
36W	LENS	20
50W	LENS	20

CW WW

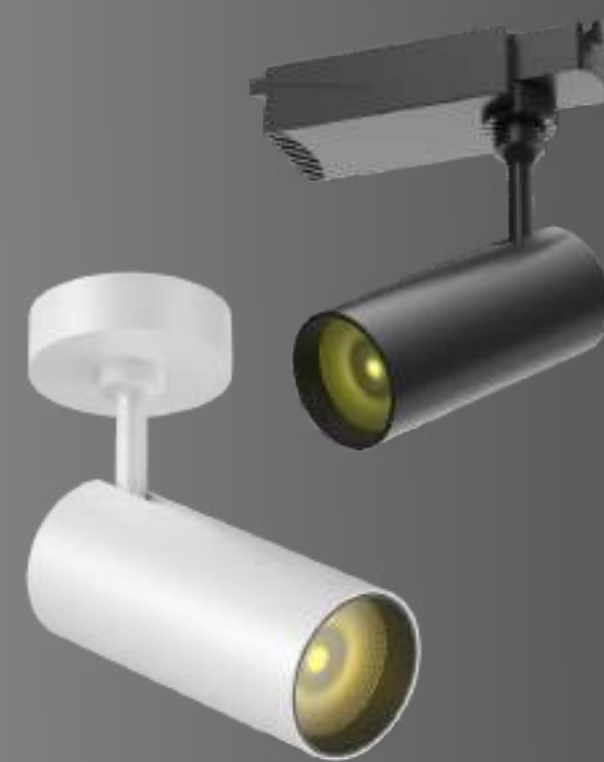

THE TRAIL

TRACK LIGHTS

The housing and gearbox for LED Track Lights are integrated together in a simple part that rotates and tilts.

WATT	TYPE	STD. Pkg. in Pcs.
10	ROUND	20
20	ROUND	20
30	ROUND	20

CW NW WW



MAC

JUNCTION DOWNLIGHT

The strong body and sleek design of MAC down light makes it ideal for lighting up any space. It has high durability and is available in many colours. Importantly, the high Lumens ensure extra brightness for that extra cheer in the room.

WATT	TYPE	STD. Pkg. in Pcs.
7W	Round	50
10W	Round	50



A new era of Enlightenment



ORA

JUNCTION DOWNLIGHT

WATT	TYPE	STD. Pkg. in Pcs.
6W	Round	50



CELIA

DOWN LIGHTS

WATT	TYPE	STD. Pkg. in Pcs.
12	Round	40

- CW + WW
- CW + RD
- CW + BL
- CW + GR
- CW + PK



High Lumen Output 100 Lm/W



ZENO

LED DOWNLIGHTS

Provides a comfortable level of brightness without the glare. A perfect amalgamation of function with style.

WATT	CUT SIZE in (mm)	STD. Pkg. in Pcs.
3W	45	100





Brand Identity, Concept & Design of Fybras Moddular Pvt. Ltd. & Balar Marketing Pvt. Ltd.

PAN INDIA PRESENCE

NORTH

DELHI
166, Functional Industrial Estate,
Patparganj, DELHI - 110092

UTTAR PRADESH
92/190, 1st Floor, Bhaskar Complex,
Adjacent Hotel S.P. International
Gautam Buddha Marg,
LUCKNOW-226018

Khasra No. 293, Hasanpur Road,
Dinanathpur Puthi, Ghaziabad
UTTAR PRADESH - 201015

RAJASTHAN
C-76, Shastri Nagar,
Near Saboo School,
JAIPUR - 302016

SOUTH

TAMILNADU
12/42, Taylors Road,
Kilpauk, CHENNAI - 600010

KERALA
Kudiyirickal Towers, First Floor,
Palarivattom, Edappally Road,
ERNAKULAM - 682025

KARNATAKA
28, Off Mysore Road
Suder Industrial Estate
New Timber Yard Layout
BANGALURU - -560026

GOA
121, Nagarathpet Main Road,
Near Kamma Temple,
BANGALORE - 560002

WEST

GUJARAT
722, Khatri Pole,
Opp. Pada Pole, Gandhi Road,
AHMEDABAD-380001

First Floor, Shop No. 82-1,
Paras Chambers, JEAN Compound,
Surendranagar - 363002

MAHARASHTRA
Gala No. 9 & 10, Blue Bell Imperial
Manas Industrial Hub,
Opp. Chinchpada, Valiv Road,
Vasai East, PALGHAR - 401208

EAST

WEST BENGAL
Flat No. 2F, Crescent Tower,
229 AJC Bose Road, Kolkata - 700 020,

Plot No. 1369, Sankrail Industrial Park
Dhulagarh, Dist Howrah
KOLKATA - 711302

BIHAR
JAK, Pratap Nagar,
Jakariyapur, Patna - 800001
Jindal House Building, P. K Sahi Lane, 5th Floor
S. P Verma Road, PATNA-800001

JHARKHAND
Plot No. 2072, Near MS Dhoni Farm House,
Vill-Simaliya, PS-Ratu, Daladili Chowk,
RANCHI - 835222

ASSAM
Dhiraj Tumung Compund,
Dag No. 102, Pamohi - DPS Road
GUWAHATI - 781035

H.O.

Balar Marketing Pvt. Ltd.
217, Functional Industrial Estate,
Patparganj, DELHI - 110 092

Fybras Moddular Pvt. Ltd.
205, 2nd floor,
Orbit Industrial Estate,
Chincholi Bunder Road,
Malad (W) MUMBAI- 400064

Balar Marketing Pvt. Ltd.
12/42, Taylors Road,
Kilpauk, CHENNAI - 600010



SAFETY BACKED WITH A STYLE STATEMENT

For more than 50 Years, our Electrical products have provided safety, security, and serenity to homes and living spaces by manufacturing Smart Electrical Products like Wires & Cables, Switchgear, Switches & Accessories and Lighting Systems that not only fulfills the needs of modern technology and design but also takes innovation to a whole new extent.



BALAR MARKETING PVT. LTD.

Regd. Corporate Office: 217, Functional Industrial Estate,
Patparganj, New Delhi - 110092, INDIA

FYBROS MODDULAR PVT. LTD.

205, 2nd Floor, Orbit Industrial Estate, Chincholi Bunder Road,
Malad (W), Mumbai - 400064



SCAN this QR - Code from your
smart phone to visit our website



fybrosofficial



fybrosofficial



fybrosofficial



fybroS



- Email: sales@fybros.com | info@fybros.com
- Website: www.fybros.com

- Toll Free Customer Support: **1800-270-6334**
- WhatsApp Virtual Assistant: **7070706737**